



Safety relays PNOZ[®], configurable control systems PNOZmulti

pilz
the spirit of safety

- ▶ Electronic monitoring relays PMDsigma and PMDsrangle
- ▶ Safety relays PNOZsigma, PNOZ X, PNOZcompact, PNOZelog and PNOZpower
- ▶ Configurable safety relays PNOZmulti Mini
- ▶ Configurable control systems PNOZmulti and PNOZmulti 2





Pilz is your solution supplier for all automation tasks. Including standard control functions. Pilz developments protect man, machine and the environment.

Pilz has a tradition as a family-run company stretching back over 60 years. Real proximity to customers is visible in all areas, instilling confidence through individual consultation, total flexibility and reliable service. Worldwide, round the clock, in 28 subsidiaries and branches, as well as 15 sales partners on every continent.

More than 1 600 staff, each one of them an ambassador for safety, make sure that your company's most valuable asset – your staff – can work safely and free from injury.



pilz
the spirit of safety

Automation solutions from Pilz – at home in every industry.





The optimum safety solution
for every requirement.

► Safety relays PNOZ® – The original

Applications worldwide – Every day, safety relays PNOZ prove themselves in millions of applications worldwide. Pilz is world market leader with its safety relay PNOZ.









Synonymous with safety – In 1987, Pilz developed the first emergency stop relay to protect man and machine. That was a milestone in safety technology. The product name PNOZ comes from the company name Pilz, NO for NOT-AUS (German for E-STOP) and Z for “zwangsgeführt” (positive-guided). Positive-guided refers to the positive guidance of the output contacts. In addition to the classic E-STOP function, our safety relays also monitor safety gates, light beam devices, two-hand controls, pressure sensitive mats, muting and many other safety functions. Today, the name PNOZ is synonymous with safety relays. Continuous development turned these simple devices into the configurable control systems PNOZmulti, the worldwide safety standard for machinery. Our current product portfolio includes the following product ranges: PNOZsigma, PNOZ X, PNOZcompact, PNOZelog, PNOZpower, PNOZmulti Mini, PNOZmulti and PNOZmulti 2.

Content

| | | | | |
|---|----|--|--|-----|
| Pilz product areas | 4 | Product group: | | |
| | | configurable safety relays PNOZmulti Mini | | 62 |
| Control technology product area | 8 | Product group: | | |
| | | configurable control systems PNOZmulti | | 72 |
| Product group: monitoring relays PMD | | Product group: | | |
| ► Electronic monitoring relays PMDsigma | 16 | configurable control systems PNOZmulti 2 | | 90 |
| ► Electronic monitoring relays PMDsrange | 18 | Accessories PNOZmulti | | 94 |
| Product group: safety relays PNOZ | | Product range: | | |
| ► Safety relays PNOZsigma | 20 | decentralised modules PDP67 and PDP20 | | 96 |
| ► Safety relays PNOZ X | 30 | ► Cable navigator | | 98 |
| ► Safety relays PNOZcompact | 38 | Safety services | | |
| ► Safety relays PNOZelog | 40 | ► Consulting, engineering and training | | 100 |
| ► Safe line inspection devices PLIDdys | 48 | | | |
| ► Safety relays PNOZpower | 50 | | | |
| Product group: software | | | | |
| ► Software tool PNOZmulti Configurator | 56 | | | |

► Business activities

| COMPONENTS | | |
|---|---|---|
| Sensor technology | <ul style="list-style-type: none"> ▶ Position monitoring devices ▶ Safety switches ▶ Safety gate systems ▶ Optoelectronic protective devices ▶ Safe camera systems |  |
| Control technology | <ul style="list-style-type: none"> ▶ Line inspection devices ▶ Monitoring relays ▶ Safety relays ▶ Configurable control systems ▶ Compact programmable control systems ▶ Modular programmable control systems ▶ Decentralised periphery |  |
| Networks | <ul style="list-style-type: none"> ▶ Safe fieldbus systems ▶ Ethernet systems ▶ Wireless systems |  |
| Drive technology | <ul style="list-style-type: none"> ▶ Motion control systems ▶ Servo amplifiers ▶ Motors |  |
| Operator and visualisation systems | <ul style="list-style-type: none"> ▶ Control and signal devices ▶ Operator terminals |  |
| Software | <ul style="list-style-type: none"> ▶ Product and system tools ▶ Application software ▶ Product-independent tools |  |
| SYSTEMS | | |
| Automation system PSS 4000 | <ul style="list-style-type: none"> ▶ Control systems ▶ Real-time Ethernet ▶ Software platform |  |
| SERVICES | | |
| Consulting and engineering | <ul style="list-style-type: none"> ▶ Risk Assessment ▶ Safety Concept ▶ Safety Design ▶ System Implementation ▶ Safety Validation ▶ CE Marking ▶ International Compliance Services ▶ Plant Assessment ▶ Inspection of ESPE |  |
| Training | <ul style="list-style-type: none"> ▶ Product-neutral seminars ▶ Product courses |  |

▶ Solution supplier for safety and standard

As market and technology leader, Pilz offers a comprehensive portfolio of products, systems and solutions for use across a range of industries. Safety or standard, plant or machine, single product or total solution – Pilz has the right answer, guaranteed. Economical, technical, personal and ecological safety are a matter of course, just as much as overall, flexible solutions.

The wide-ranging **sensor technology** portfolio provides the right sensor for each application. In conjunction with safe control technology, the result is a safe, economical, approved and complete solution.

Control technology enables numerous application options, including monitoring of electrical and functional safety, through to complete machine control: from a simple machine through to a distributed plant with a wide range of standard and safety functions.

Networks are clear and powerful due to compatible communication systems and network components. Diverse technologies enable a variety of solution approaches, including wireless, fieldbus and Ethernet systems.

 Webcode 5172

 Webcode 5213

 Webcode 5528

Drive technology ranges from drive-integrated safety functions to safe logic functions, through to connection of visualisation, sensor and actuator technology for every system environment.

Operator and visualisation systems enable short reaction times through control and signal devices, as well as rapid diagnostics via visualisation systems. As the ideal supplement for other Pilz products, your plant is completed reliably and in compliance with the standards.

Whatever the task, our **software** has the right tool. This includes application software, such as function blocks, product and system tools, as well as product-independent tools. The focus is on intuitive operation.

 Webcode 5261

 Webcode 5292

 Webcode 5435

The **automation system PSS 4000** for standard and safety is ideal for automation solutions in every industry. Interaction between the most diverse components, the software platform PAS4000 and the real-time Ethernet SafetyNET p are the system's distinguishing features.

Our **services** include consulting, technical implementation and training in the field of machinery safety. Our experts will guide you through the whole machine lifecycle, through to CE certification.

 Webcode 5092

 Webcode 7792

► Safety relays PNOZ[®] and configurable control sys

We can offer the optimum safety solution for each application. For us, safety is more than just a product, it is an obligation. Safe control technology is our core competency. Let Pilz's experience work for you. We are continually expanding our product range in consultation with you, our customers.

Our safety relays are distinguished by a variety of supply voltage ranges, the number of safety contacts, the number of terminals or the ability to plug in terminals.

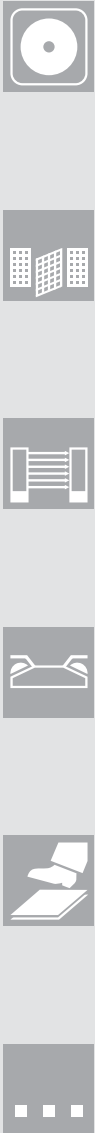

The configurable control systems require a software tool for configuration. Based on their different features and functionalities, our products can be divided into the following product ranges:

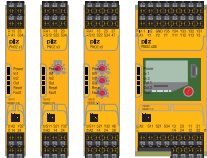

PNOZsigma



PNOZ X

PNOZcompact

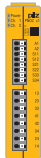

PNOZelog

PNOZpower

Safety relays

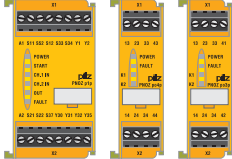
PNOZsigma

- Maximum functionality in minimum width
- Operating modes and times are selectable
- Scalability thanks to modular structure

PNOZ X

- Tailor-made safety for each function
- Electromechanical, volt-free
- With universal power supply

PNOZcompact

- Square, simple, yellow
- Ideal for high volume manufacturers of series machines
- Basic function of a safety application

PNOZelog

- Easy to link
- Non-wearing
- Expanded diagnostics

PNOZpower

- High loads from 8 A to 16 A
- Switch motor loads directly
- Modular output contacts

tems PNOZmulti

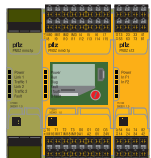

PNOZmulti Mini

PNOZmulti

PNOZmulti 2

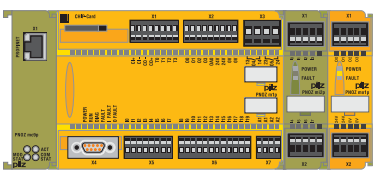
Configurable control systems

- ▶ Freely configurable with the software tool PNOZmulti Configurator
- ▶ Worldwide safety standard for all machine types

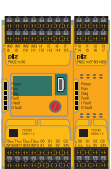
PNOZmulti Mini

- ▶ As simple as a safety relay, as flexible as a control system
- ▶ Base units only 45 mm wide, with display
- ▶ Stand-alone and modular, expandable version

PNOZmulti/PNOZmulti 2

- ▶ Many functions, one solution
- ▶ From 3 safety functions
- ▶ For safety and standard control systems



Keep up-to-date on: Safety relays

 Webcode 5513

Control systems

 Webcode 5245

Online information at www.pilz.com

► Safety relays PNOZ® and configurable control sys

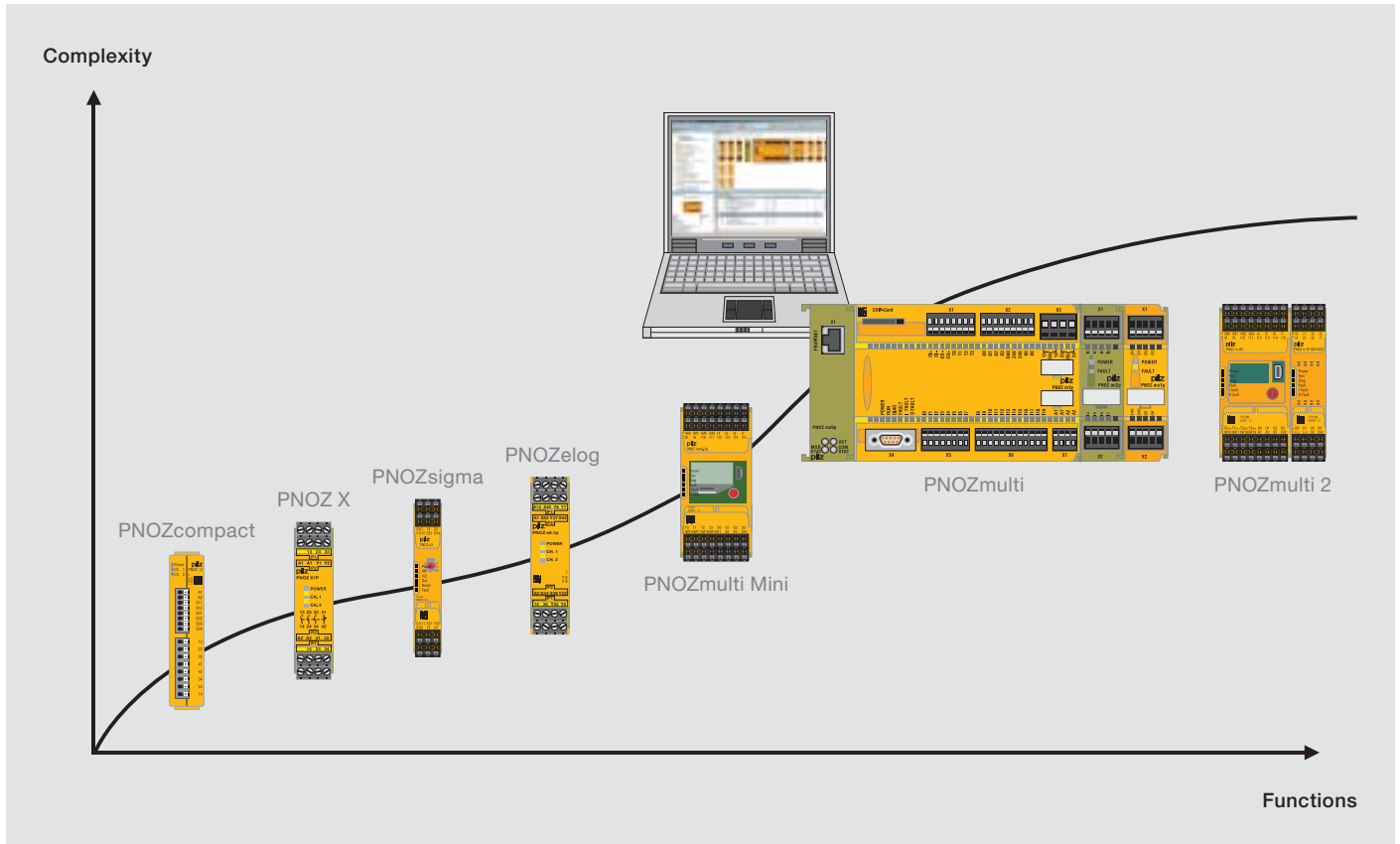

Pilz offers a universal concept of safety-related solutions, from a simple machine through to complex plants.



Keep up-to-date on: Safety relays

Webcode 5513

Control systems

Webcode 5245

Online information at www.pilz.com



tems PNOZmulti

Finding your PNOZ
This diagram will help you to choose.
You have specific requirements,
we have the right solution.



More than three safety functions/configurable?

Yes

PNOZmulti Mini
Further information from page 62

PNOZmulti
Further information from page 72

Breaking capacity > 8 A?

Yes

PNOZmulti2
Further information from page 90

PNOZmulti Configurator
Further information from page 56

Good scalability/
user-friendly diagnostics?

No

Plug-in terminals/universal
power supply?

No

PNOZpower
Further information from page 50

PNOZsigma
Further information from page 20

Ability to connect
safety functions
via AND/OR logic

Yes

PNOZelog
Further information from page 40

PNOZ X
Further information from page 30

PNOZcompact
Further information from page 38

► The standard in safe control technology

It pays to use safety technology – The protection of man and machine through the targeted control of hazardous movements, cost savings thanks to fewer accidents, reduced downtimes and fewer production losses – these are real benefits that you can enjoy when you use safe control technology from Pilz.

Safety relays PNOZ –

Certified worldwide

When using the safety relays PNOZ, the aim is to keep the risk to man and machine as low as possible. Internationally co-ordinated statutory instruments were introduced to ensure that the same level of protection could be guaranteed in all countries. Our safety relays comply with these international standards and regulations. The safety relay PNOZ has been approved by BG, TÜV and many other notified bodies and offers users considerable benefits. Long service life and high availability ensure it is cost-effective to use.

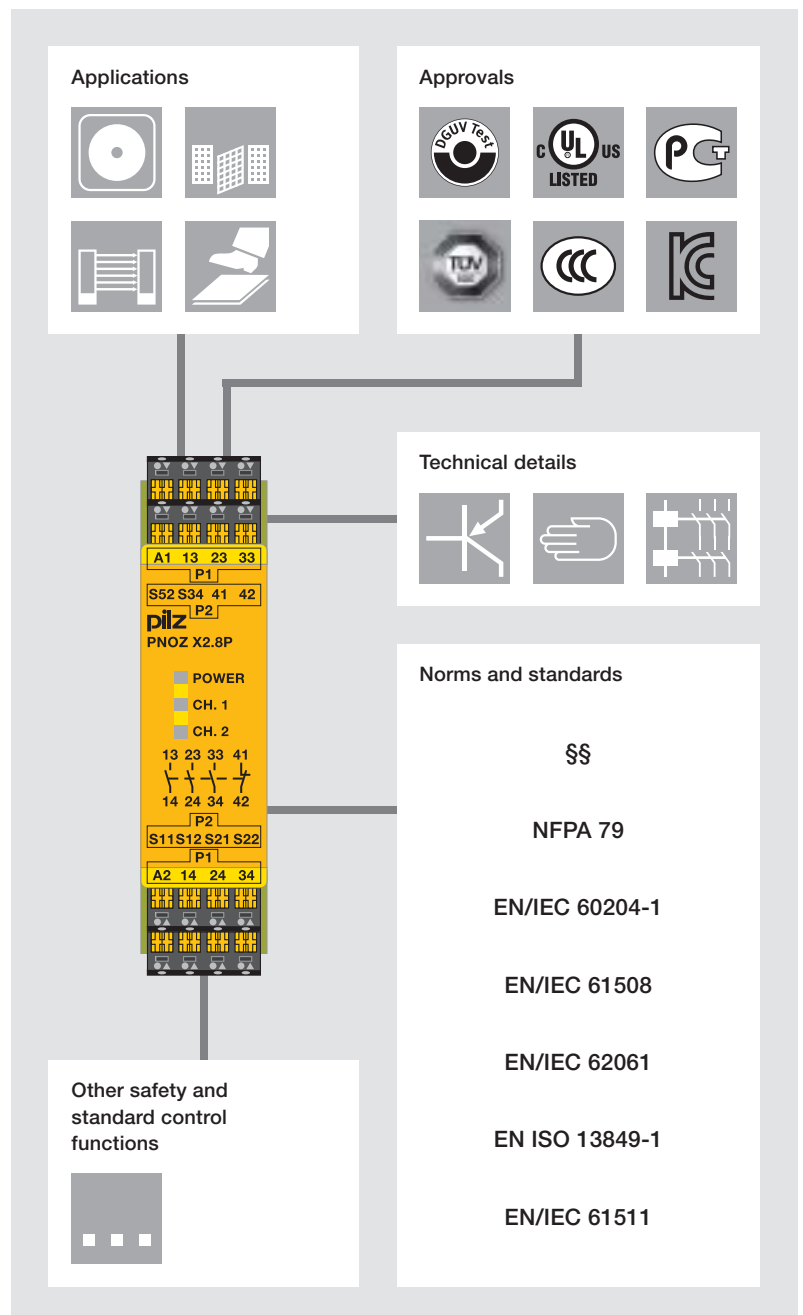

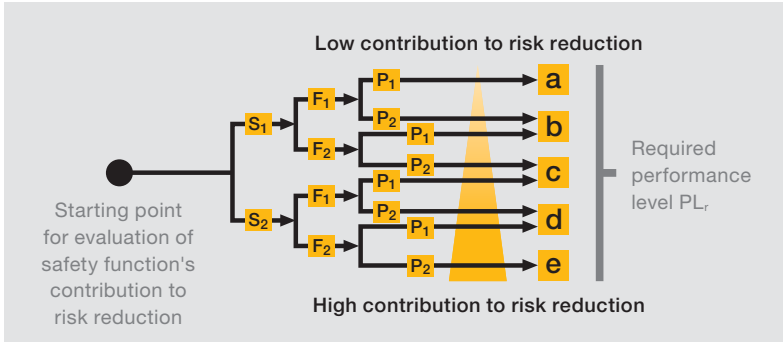

Risk analysis in accordance with EN 13849-1

EN ISO 13849-1

As the successor standard to EN 954-1, EN ISO 13849-1 is based on the familiar categories. Equally, it examines complete safety functions, including all the components involved in their design. EN ISO 13849-1 goes beyond the qualitative approach of EN 954-1 to include a quantitative assessment of the safety functions. A performance level (PL) is used for this, building upon the categories.

| Consequences | Se | Class CL = Fr + Pr + Av | | | | |
|-------------------------------|----|-------------------------|-------|-------|-------|-------|
| | | 3-4 | 5-7 | 8-10 | 11-13 | 14-15 |
| Death, losing an eye or arm | 4 | SIL 2 | SIL 2 | SIL 2 | SIL 3 | SIL 3 |
| Permanent, losing fingers | 3 | | OM | SIL 1 | SIL 2 | SIL 3 |
| Reversible, medical attention | 2 | | | OM | SIL 1 | SIL 2 |
| Reversible, first aid | 1 | | | | OM | SIL 1 |

Risk assessment and definition of the required safety integrity level (SIL)

Safety assessment in accordance with EN/IEC 62061

According to the standard EN/IEC 62061, safety requirements in control technology can be divided into safety integrity levels. SIL 3 represents the highest risk reduction and protection level, where the safety function must always be maintained. The risk is estimated through consideration of the severity of injury (Se), the frequency and duration of exposure to the hazard (Fr), probability of occurrence of a hazardous event (Pr) and the possibility of avoiding or limiting the harm (Av).

Your benefits at a glance

The use of safety relays PNOZ offers you:

- ▶ The security and innovative strength of one of the leading brands in automation technology
- ▶ The appropriate solution for each application
- ▶ High plant availability thanks to user-friendly diagnostics
- ▶ Low downtimes for your plant or machinery
- ▶ Optimum cost/performance ratio
- ▶ Faster commissioning, for example, through units with plug-in terminals
- ▶ Maximum safety with minimum space requirement
- ▶ Simple wiring, fast commissioning
- ▶ A solid partner with expertise
- ▶ Certified safety, because our products comply with international standards and regulations and have been tested and approved worldwide
- ▶ Quality guarantee, we are certified to DIN ISO 9001
- ▶ Use of products that are geared towards the future, thanks to innovative developments
- ▶ Complete solution comprising evaluation devices, compatible sensor technology and control and signal devices

Find out more about the standards:

 Webcode 0240

Online information at www.pilz.com

► Save costs with push-in technology

Unit types in push-in technology offer a great advantage in terms of both economy and safety. They help you to reduce costs through short commissioning and service times.

The following product ranges are available in push-in technology:

- Monitoring relays PMDsigma
- Line inspection devices PLIDdys
- Safety relays PNOZsigma, PNOZ X, PNOZcompact, PNOZelog
- Configurable control systems PNOZmulti Mini, PNOZmulti and PNOZmulti 2

Easy to service through simple operation

All standard cables, with or without crimp connectors, can be connected. Wiring is quick and easy. Pilz terminals provide a dual connection option per pole; these can be opened individually or both simultaneously. This is beneficial during installation or when modifying the wiring, as only the required terminal point is opened. For total security, Pilz plug-in terminals have a separate opening for testing the voltage. Coded connectors guarantee simple, foolproof installation, better handling security when servicing and therefore reduced downtimes and lower costs.

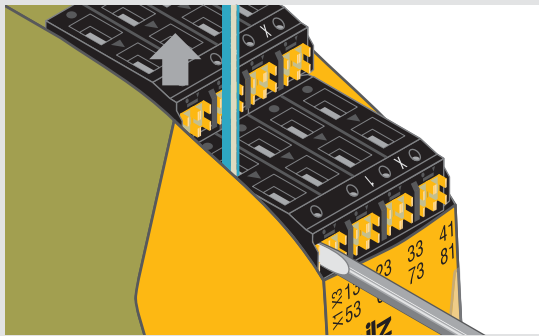

Left-hand actuator, rear terminal

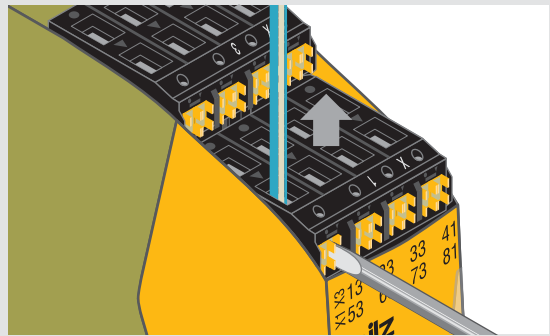

Right-hand actuator, front terminal

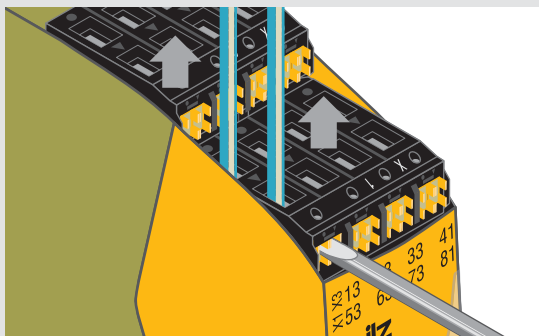

Both terminals opened simultaneously by placing the screwdriver crossways

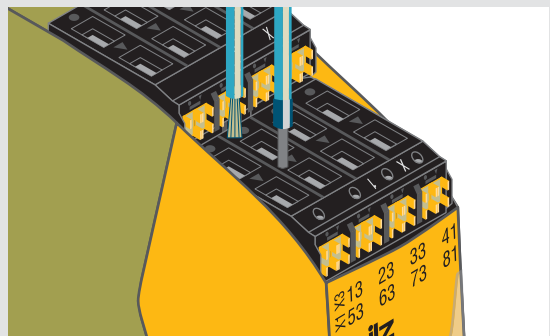

Terminals suitable for fine-wire strands or crimp connections

Each pole can be released separately

High contact security

Spring-loaded terminals are maintenance-free due to the predefined clamping force and, unlike screw terminals, do not need to be regularly re-tightened. So there are no subsequent costs from having to tighten up the terminals.

Much easier to loop through

The special feature with Pilz double level terminal blocks is the ability to connect two cables with a cross-section of up to 1.5 mm² per pole. So even with push-in technology, it's much easier to loop through.

Benefits at a glance

- ▶ Save costs through faster wiring, saving a lot of time when servicing
- ▶ Maintenance-free due to high contact security, even when faced with heavy shock and vibration
- ▶ Double level terminal blocks provide ease-of-use in all applications
- ▶ Flexible to use, downtimes can be reduced thanks to rapid fault detection when wiring
- ▶ Save costs when exchanging units, as there's no need to rewire – thus eliminating potential wiring errors

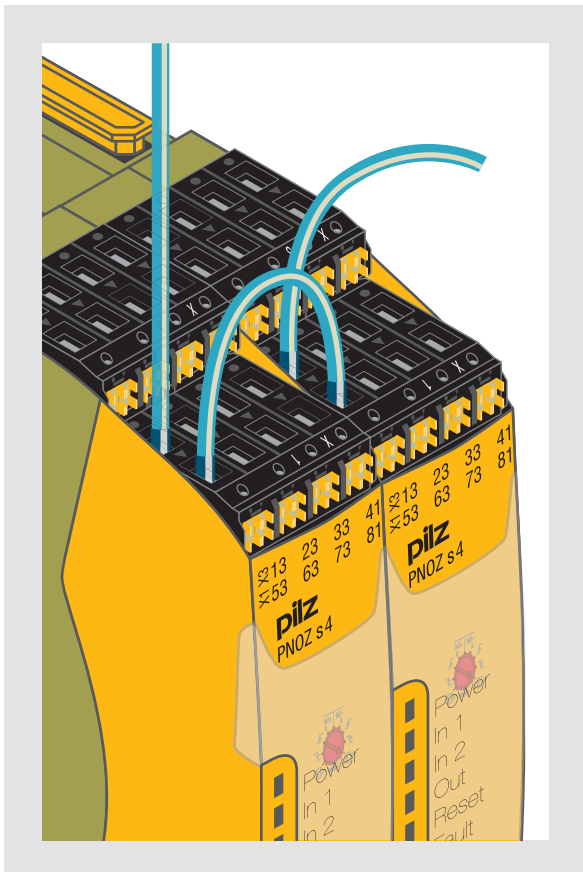

Loop through

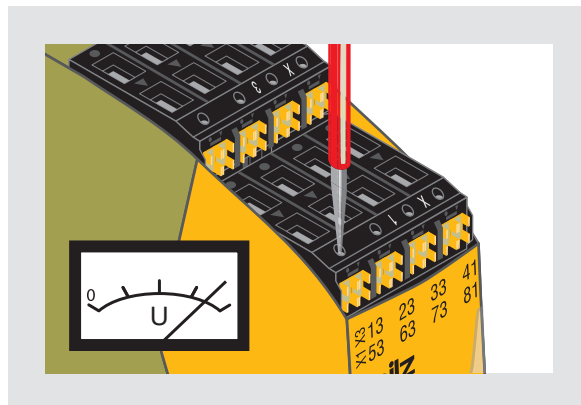

Simple voltage test

▶ Electrical safety with the electronic monitoring

On electronic monitoring relays, electrical safety is the focus. Electronic monitoring relays reduce the number of hazardous situations for man and machine and increase the service life of plant and machinery. Save costs and guarantee an efficient production cycle.



PMD s10

Applications PMD s10

Using the measured true power, it is possible to derive variables such as fill level, volume, torque or air pressure, for example. The following applications illustrate potential areas of use, by way of example:

- ▶ Contamination of sieves or filters on ventilation systems
- ▶ To check for dry running or pump blockage
- ▶ Viscosity of fluids on mixers
- ▶ Wear and tear on tools
- ▶ To control the brush pressure on car washes
- ▶ To monitor conveyors for blockages or wear and tear



Technical details – Electronic monitoring relays PMDsigma



PMD s20

| Type | Application area | Dimensions (H x W x D) in mm |
|---------|--|---------------------------------|
| PMD s10 | Monitors and converts true power for single/three-phase AC/DC supplies, relay and analogue outputs, monitors overload and underload. Suitable for use with frequency-controlled motors and current transformers. | 100/98 ¹⁾ x 45 x 120 |
| PMD s20 | Monitors the insulation resistance of unearthed AC/DC systems (IT systems) | 100/98 ¹⁾ x 45 x 120 |

relays PMDsigma

Applications PMD s20

The PMD s20 can be used to monitor the insulation resistance of unearthed AC/DC systems. Thanks to the separate supply voltage, monitoring of the de-energised system is possible. Typical application areas include:

- ▶ Clinical operating theatres
- ▶ Offshore installations such as wind turbines, clarification plants and shiplifts
- ▶ Electroplating and surface finishing systems

Your benefits at a glance

- ▶ For universal use: only one unit to stock
- ▶ Quick and easy settings, just turn and click, so set-up and commissioning times are short
- ▶ Failsafe: menu-based configuration
- ▶ Ideal when exchanging units: configuration is stored on the chip card
- ▶ Simple diagnostics via the display mean minimum downtimes
- ▶ Approved for applications worldwide



| Features | Order number |
|--|--|
| <ul style="list-style-type: none"> ▶ Measuring range is set automatically for current and voltage ▶ Function parameter settings are menu-driven ▶ Analogue outputs for current and voltage. Voltage output 0 ... 10 V. Current output convertible from 0 ... 20 mA to 4 ... 20 mA. ▶ Relay outputs for monitoring underload and overload ▶ Supply voltage (U_B): 24 ... 240 VAC/DC ▶ Output contacts: 2 auxiliary contacts (C/O) ▶ Measuring voltage (3 AC), U_M (AC/DC): 100 ... 550 V ▶ Measuring current (I_M): 1 ... 12 A AC/DC | <ul style="list-style-type: none"> ▶ Spring-loaded terminals PMD s10 C _____ 761 100 ▶ Plug-in screw terminals PMD s10 _____ 760 100 |
| <ul style="list-style-type: none"> ▶ Response value R_{on}: selectable from 10 ... 200 kΩ ▶ Voltage: <ul style="list-style-type: none"> - Voltage supply via universal power supply: 24 ... 240 VAC/DC - Measuring voltage of the IT system to be monitored: 0 ... 400 VAC/DC ▶ Frequency range AC: 50 ... 60 Hz ▶ Start-up suppression/reaction time: selectable from 0 ... 30 s ▶ Hysteresis: selectable from 0 ... 50 % | <ul style="list-style-type: none"> ▶ Spring-loaded terminals PMD s20 C _____ 761 120 ▶ Plug-in screw terminals PMD s20 _____ 760 120 |



Keep up-to-date on PMDsigma:

Webcode 5215

Online information at www.pilz.com

¹⁾ Height with spring-loaded terminals/plug-in screw terminals

▶ Electronic monitoring relays PMDsigma



S3UM



S1IM



S1WP

Reliably taking control of every situation

Reliable electronic monitoring and control of plant and machinery is at the heart of our range of monitoring relays. PMDsigma units in 22.5 mm slimline housing cover the widest range of functions.

Selection guide – Electronic monitoring relays PMDsigma



| Type | Technical features |
|-------------|--|
| S3UM | <p>Monitors AC voltages for overvoltage and undervoltage, phase sequence/failure and asymmetry, three-phase</p> <ul style="list-style-type: none"> ▶ Monitors supplies with and without neutral conductors ▶ Trip device for undervoltage and overvoltage ▶ Evaluates phase sequence ▶ Detects asymmetry and phase failure |



| | |
|-------------|--|
| S1PN | <p>Monitors phase sequence and phase failure on three-phase supplies</p> <ul style="list-style-type: none"> ▶ Measuring voltage up to 690 VAC ▶ Monitors phase sequence, phase failure, fuse |
|-------------|--|



| | |
|-------------|--|
| S1IM | <p>Monitors AC/DC currents for max. current values, single-phase</p> <ul style="list-style-type: none"> ▶ 12 measuring ranges can be selected from 0.002 to 15 A ▶ Reaction time can be set to up to 10 seconds ▶ Operates to either normally energised or normally de-energised mode ▶ Galvanic isolation between measuring and supply voltage ▶ UP version: measuring inputs are not polarity-sensitive |
|-------------|--|



| | |
|-------------|--|
| S1EN | <p>Monitors insulation and earth faults on galvanically isolated AC/DC supplies, single and three-phase</p> <ul style="list-style-type: none"> ▶ For DC and AC supplies ▶ Normally energised mode ▶ Fault latching or automatic reset ▶ Normal/test mode ▶ External reset button can be connected |
|-------------|--|



| | |
|-------------|--|
| S1WP | <p>Monitors and converts true power, DC supplies and single-/three-phase AC supplies, relay and analogue output, monitors overload and underload</p> <ul style="list-style-type: none"> ▶ Nine different measuring ranges ▶ Large voltage measuring range ▶ Analogue output can be switched for current and voltage ▶ Relay output for monitoring underload and overload ▶ Suitable for use with frequency-controlled motors ▶ Suitable for current transformers |
|-------------|--|



| | |
|-------------|---|
| S1MS | <p>Monitors the temperature of PTC temperature sensors to protect the motor from overheating</p> <ul style="list-style-type: none"> ▶ For DC and AC supplies ▶ Normally energised mode ▶ Automatic reset |
|-------------|---|

In addition to current, voltage and insulation monitors, the range also includes relays for true power, phase sequence and thermistor monitoring. Quick and easy installation, practical terminals, a variety of operator elements as well as luminous displays all help to make commissioning easier and ensure the units are perfectly tailored to the specific application.



Your benefits at a glance

- ▶ Parameters can be set on the front, meaning short commissioning times
- ▶ Save space in the control cabinet: widths of just 22.5 mm
- ▶ Rapid diagnostics via LED status display

| | Order number ¹⁾ |
|---|--|
| <ul style="list-style-type: none"> ▶ Supply voltage (U_B): AC: 120, 230 V; DC: 24 V ▶ Output contacts: 1 auxiliary contact (C/O) ▶ Measuring voltage (3 AC) (U_M): AC: 42, 230, 100/110, 400/440, 440/480, 415/460, 500/550 V, selectable ▶ Dimensions (H x W x D): 87 x 22.5 x 122 mm | <ul style="list-style-type: none"> ▶ 24 VDC (U_B), 230 VAC (U_M) _____ 837 260 ▶ 24 VDC (U_B), 400/440 VAC (U_M) _____ 837 270 ▶ 24 VDC (U_B), 415/460 VAC (U_M) _____ 837 280 |
| <ul style="list-style-type: none"> ▶ Supply voltage (U_B): AC: 200 ... 240, 400 ... 500, 550 ... 690 V ▶ Output contacts: 2 auxiliary contacts (2 C/O) ▶ Dimensions (H x W x D): 87 x 22.5 x 121 mm | <ul style="list-style-type: none"> ▶ 200 ... 240 V _____ 890 200 ▶ 400 ... 500 V _____ 890 210 ▶ 550 ... 690 V _____ 890 220 |
| <ul style="list-style-type: none"> ▶ Supply voltage (U_B): AC: 24, 42 ... 48, 110 ... 127, 230 ... 240 V; DC: 24 V ▶ Output contacts: 1 auxiliary contact (C/O) ▶ Dimensions (H x W x D): 87 x 22.5 x 121 mm | <ul style="list-style-type: none"> ▶ 110 ... 130 VAC (U_B), 15 A (I_M) _____ 828 040 ▶ 230 ... 240 VAC (U_B), 15 A (I_M) _____ 828 050 ▶ 24 VDC (U_B), 15 A (I_M) _____ 828 035 |
| <ul style="list-style-type: none"> ▶ Supply voltage (U_B): AC/DC: 24 ... 240 V ▶ Output contacts: 1 auxiliary contact (C/O) ▶ Rated mains voltage (monitored supply): <ul style="list-style-type: none"> - 50 kΩ version: AC/DC: 0 ... 240 V - 200 kΩ version: AC/DC: 0 ... 400 V ▶ Dimensions (H x W x D): 87 x 22.5 x 121 mm | <ul style="list-style-type: none"> ▶ 24 ... 240 VAC/DC (U_B), 50 kΩ _____ 884 100 ▶ 24 ... 240 VAC/DC (U_B), 200 kΩ _____ 884 110 |
| <ul style="list-style-type: none"> ▶ Supply voltage (U_B): DC: 24 V, AC/DC: 230 V ▶ Output contacts: 1 auxiliary contact (C/O) ▶ Measuring voltage: 3 AC/1 AC/DC: <ul style="list-style-type: none"> 0 ... 70, 0 ... 120, 0 ... 140, 0 ... 240, 0 ... 320, 0 ... 415, 0 ... 550 V ▶ Dimensions (H x W x D): 87 x 22.5 x 121 mm | <ul style="list-style-type: none"> ▶ 9 A (I_M), 24 VDC (U_B), <ul style="list-style-type: none"> 0 ... 240 VAC/DC _____ 890 010 ▶ 9 A (I_M), 24 VDC (U_B), <ul style="list-style-type: none"> 0 ... 415 VAC/DC _____ 890 020 ▶ 9 A (I_M), 24 VDC (U_B), <ul style="list-style-type: none"> 0 ... 550 VAC/DC _____ 890 030 |
| <ul style="list-style-type: none"> ▶ Supply voltage (U_B): AC: 48, 110, 230, 240, 400 V; AC/DC: 24 V ▶ Output contacts: 2 auxiliary contacts (2 C/O) ▶ Dimensions (H x W x D): 87 x 22.5 x 121 mm | <ul style="list-style-type: none"> ▶ 24 VAC/DC (U_B) _____ 839 775 ▶ 230 VAC (U_B) _____ 839 760 ▶ 400 VAC (U_B) _____ 839 770 |



¹⁾ Additional versions on request

Order number features: U_B = Supply voltage; U_M = Measuring voltage; I_M = Measuring current

► Safety relays PNOZsigma

The compact safety relays PNOZsigma combine many years of experience with today's very latest safety technology: you can achieve maximum safety and cost-effectiveness with minimum effort. With particularly narrow housing widths and multifunctionality compressed into each unit, PNOZsigma provides maximum functionality in minimum width. So you can implement safety technology faster, with greater flexibility and therefore more efficiently, while saving space.



PNOZ s1

PNOZ s3

PNOZ s5

PNOZ s30

Fewer types – suitable for a variety of uses

- Selectable operating modes and timers enable each unit to be flexible in its application
- A single unit type monitors different safety functions
- Your stockholding can be reduced to a few unit types

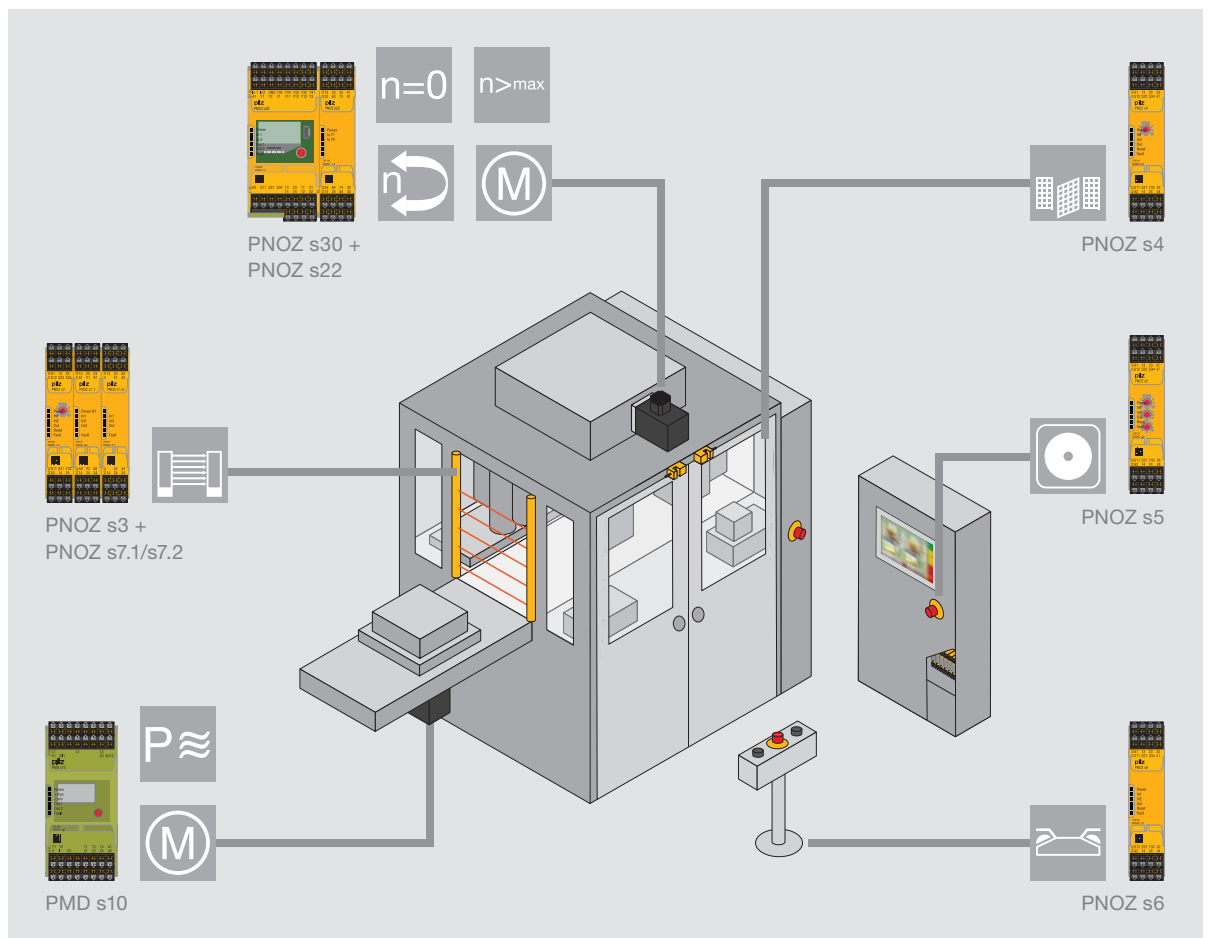

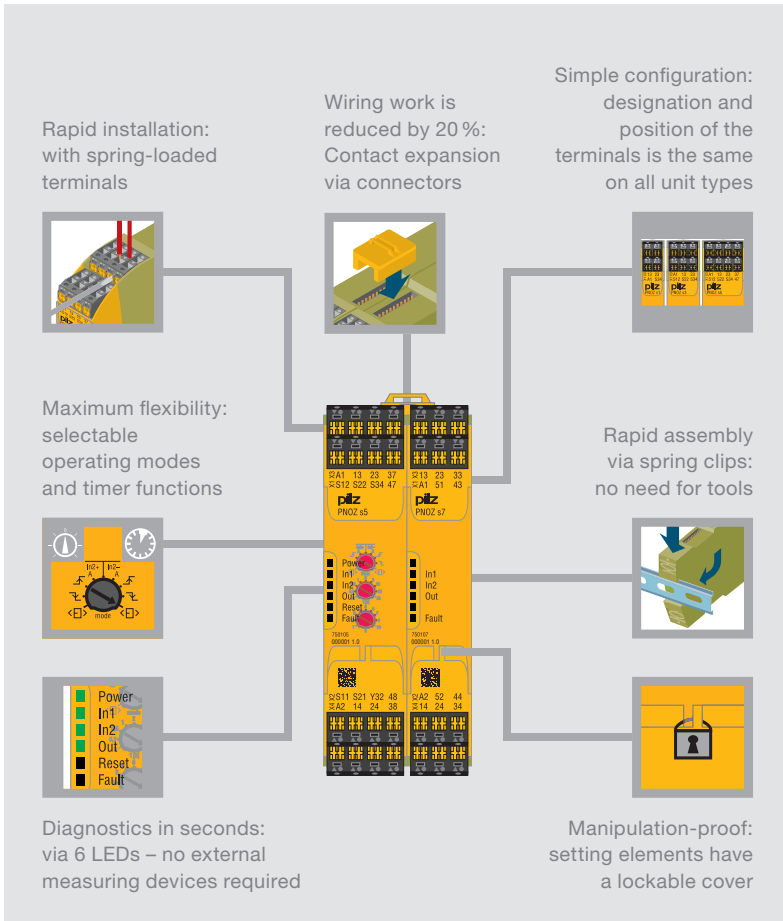

Your benefits at a glance

- ▶ Narrower widths save space within the control cabinet, and therefore costs!
- ▶ Reduce wiring costs through push-in technology and expand the number of contacts via connectors
- ▶ Rapid commissioning and high availability
- ▶ Low logistics costs: few unit types covering many safety functions
- ▶ Use the complete solution from Pilz and supplement the PNOZsigma with compatible, approved safety components: from E-STOP pushbuttons to safe sensors such as safety switches and light curtains, through to operator terminals for diagnostics and visualisation

Up to 50 % space saving

- ▶ Widths from 12.5 mm
- ▶ Housing is up to 50 % narrower with the same functionality ¹⁾
- ▶ Reduced space requirement in the control cabinet saves costs

¹⁾ Compared with standard electromechanical safety relays on the market

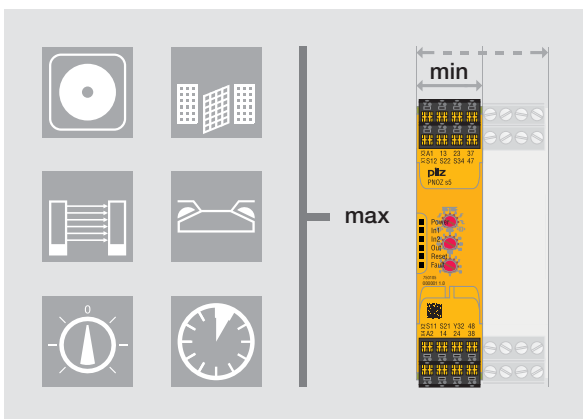

Keep up-to-date on safety relays PNOZsigma:

Webcode 5229

Online information at www.pilz.com

► Convenient speed monitoring

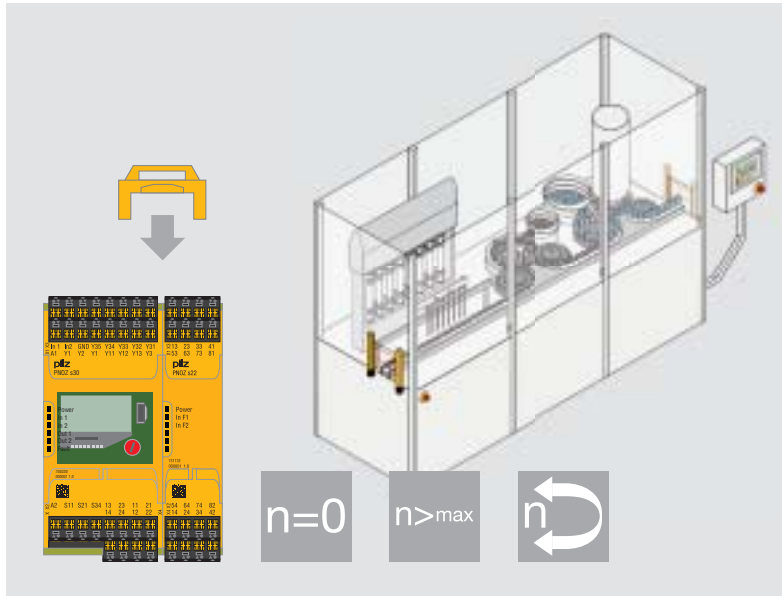

Relay contacts can be multiplied by combining PNOZ s22 and PNOZ s30.

Safe speed monitor PNOZ s30

Convenient speed monitoring – the speed monitor PNOZ s30 provides safe monitoring of standstill, speed, direction of rotation and shear pin breakage. For example, travelling at reduced speed during set-up mode increases operator safety. Productivity is increased, as an unnecessary shutdown is prevented. This all saves costs and protects machinery as well as staff. It also enables you to comply with the requirement of the new Machinery Directive, which states that in the field of drive monitoring, the operating status must be safely monitored and maintained when the drive is brought to a standstill. Typical applications are pleasure parks, balancing machines, high bay racking, centrifuges, filling machines, machining centres, wind turbines.

Your benefits at a glance

- Increased productivity and safety for operating personnel
- Productivity is increased by avoiding unnecessary shutdown processes: advance warning is given when a defined warning threshold is reached
- Save time during setup and when units are exchanged, thanks to convenient operation via rotary knob (push and turn)
- Suitable for all common motor feedback systems and proximity switches
- Contact expansion module PNOZ s22: duplication of the relay contacts enables the application's function range to be expanded

Contact expansion module PNOZ s22 – Twice as good

PNOZ s22 provides two relay functions that can be controlled separately in accordance with PL e of EN ISO 13849-1. Each relay function provides 3 N/O/1 N/C contact. These can be controlled separately, so that the outputs can be assigned different functions, depending on the base unit. Safe separation between the two relay functions enables different potentials to be switched.

Keep up-to-date on safety relays PNOZsigma:



Webcode 5229

Online information at www.pilz.com



► PNOZsigma types

Safety relay PNOZ s4 with approval in accordance with EN 81-1/A3

The “Lifts standard” EN 81-1 defines the safety rules for the “construction and installation of lifts; Part 1: Electric lifts”. The PNOZ s4 has this approval and guarantees lift operators and lift manufacturers maximum functionality in minimum width. At a width of 22.5 mm, PNOZ s4 achieves PL e of EN ISO 13849-1 and SIL CL claim 3. The application area of PNOZ s4 extends from passenger lifts and goods/service lifts through to all types of lifting machinery, which are subject to this standard.

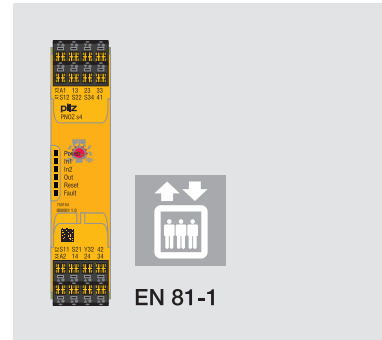

Safe firing with PNOZ s4.1

Thanks to three safe, diverse safety contacts, the PNOZ s4.1 is approved for use in burner controls. It is approved in accordance with the standard EN 50156-1 for electrical equipment on furnaces, in particular with regard to the requirements for application design and installation.

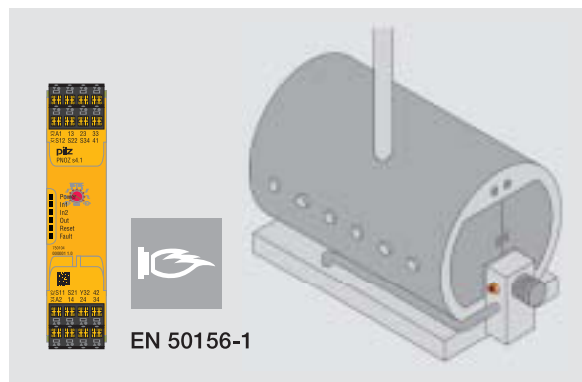

Multiple expansion with PNOZ s7.1 and PNOZ s7.2

With a base unit and a PNOZ s7.1, the number of safety contacts can be expanded almost without limit. Up to ten PNOZ s7.2 can be connected to a PNOZ s7.1. If you need more contacts, an additional PNOZ s7.1 can be added to the series. No wiring is involved – just a connector and one simple hand movement.

At just 17.5 mm wide, the PNOZ s7.1 has three safety contacts, while the PNOZ s7.2 has four safety contacts plus one auxiliary contact. They can be combined with other PNOZsigma expansion units at any time.

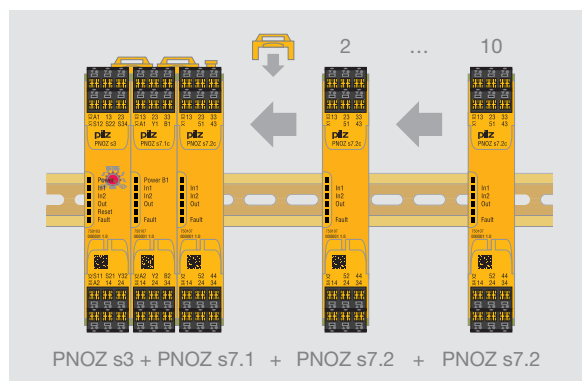

Rapid contact expansion – it’s easy with PNOZsigma!





► Selection guide – PNOZsigma





Safety relays PNOZsigma

| Type | Application | Performance Level (PL) – EN ISO 13849-1 |
|-----------|---|---|
| | | |
| PNOZ s1 | ◆ ◆ | c |
| PNOZ s2 | ◆ ◆ | e |
| PNOZ s3 | ◆ ◆ ◆ | e |
| PNOZ s4 | ◆ ◆ ◆ | e |
| PNOZ s4.1 | ◆ ◆ ◆ | e |
| PNOZ s5 | ◆ ◆ ◆ ◆ | e |
| PNOZ s6 | ◆ EN 574, Type IIIC | e |
| PNOZ s6.1 | ◆ EN 574, Type IIIA | c |
| PNOZ s7 | Contact expansion | e |
| PNOZ s7.1 | Contact expansion | e |
| PNOZ s7.2 | Contact expansion | e |
| PNOZ s8 | Contact expansion | c |
| PNOZ s9 | Contact expansion or safe timer relay ◆ | e |
| PNOZ s10 | Contact expansion | e |
| PNOZ s11 | Contact expansion | e |
| PNOZ s22 | Contact expansion for PNOZ s30 and PNOZ mm0.1p/mm0.2p | e |

| Type | Application | Performance Level (PL) – EN ISO 13849-1 |
|----------|---------------------|---|
| | | |
| PNOZ s30 | Speed monitor ◆ ◆ ◆ | e |



| Safety Integrity Level (SIL) CL – claim limit in accordance with IEC 62061 | Output contacts | | | | Universal power supply 48 ... 240 VAC/DC | Housing width in mm |
|--|---|---|---|---|---|------------------------|
| | Safe | | Auxiliary contacts | | | |
| |  |  |  |  | | |
| 2 | 2 | - | - | 1 | | 12.5 |
| 3 | 3 | - | 1 | 1 | | 17.5 |
| 3 | 2 | - | - | 1 | | 17.5 |
| 3 | 3 | - | 1 | 1 | ◆ | 22.5 |
| 3 | 3 | - | 1 | 1 | ◆ | 22.5 |
| 3 | 2 | 2 | - | 1 | ◆ | 22.5 |
| 3 | 3 | - | 1 | 1 | ◆ | 22.5 |
| 1 | 3 | - | 1 | 1 | ◆ | 22.5 |
| 3 | 4 | - | 1 | - | | 17.5 |
| 3 | 3 | - | - | - | | 17.5 |
| 3 | 4 | - | 1 | - | | 17.5 |
| 2 | 2 | - | - | 1 | | 12.5 |
| 3 | - | 3 | 1 | - | | 17.5 |
| 3 | 4 | - | 1 | - | | 45.0 |
| 3 | 8 | - | 1 | - | | 45.0 |
| 3 | 2x3 | - | 2x1 | - | | 22.5 |

| Safety Integrity Level (SIL) CL – claim limit in accordance with IEC 62061 | Output contacts | | | | Universal power supply 24 ... 240 VAC/DC | Housing width in mm |
|--|---|---|---|---|---|------------------------|
| | Safe | | Auxiliary contacts | | | |
| |  |  |  |  | | |
| 3 | 2 | - | 2 | 4 | ◆ | 45.0 |

Technical documentation on safety relays PNOZsigma:

 Webcode 0685

Online information at www.pilz.com

► Technical details – PNOZsigma



Safety relays PNOZsigma



| Type | Supply voltage (U _B) | Outputs: Voltage/current/rating | Dimensions (H x W x D) in mm |
|-----------|---|------------------------------------|------------------------------------|
| PNOZ s1 | 24 VDC | DC1: 24 V/3 A/72 W | 100/98 ¹⁾ x 12.5 x 120 |
| PNOZ s2 | 24 VDC | DC1: 24 V/6 A/150 W | 102/96 ¹⁾ x 17.5 x 120 |
| ★ PNOZ s3 | 24 VDC | DC1: 24 V/6 A/150 W | 102/96 ¹⁾ x 17.5 x 120 |
| ★ PNOZ s4 | <ul style="list-style-type: none"> ▶ 24 VDC ▶ 48 ... 240 VAC/DC | DC1: 24 V/6 A/150 W | 102/96 ¹⁾ x 22.5 x 120 |
| PNOZ s4.1 | <ul style="list-style-type: none"> ▶ 24 VDC ▶ 48 ... 240 VAC/DC | DC1: 24 V/6 A/150 W | 102/96 ¹⁾ x 22.5 x 120 |
| ★ PNOZ s5 | <ul style="list-style-type: none"> ▶ 24 VDC ▶ 48 ... 240 VAC/DC | DC1: 24 V/6 A/150 W | 102/96 ¹⁾ x 22.5 x 120 |
| PNOZ s6 | <ul style="list-style-type: none"> ▶ 24 VDC ▶ 48 ... 240 VAC/DC | DC1: 24 V/6 A/150 W | 100/98 ¹⁾ x 22.5 x 120 |
| PNOZ s6.1 | <ul style="list-style-type: none"> ▶ 24 VDC ▶ 48 ... 240 VAC/DC | DC1: 24 V/6 A/150 W | 100/98 ¹⁾ x 22.5 x 120 |

| Features | Order numbers | |
|---|--|--|
| | Spring-loaded terminals | Plug-in screw terminals |
| <ul style="list-style-type: none"> ▶ Single-channel wiring ▶ Manual/automatic reset | 751 101 | 750 101 |
| <ul style="list-style-type: none"> ▶ Single-channel wiring ▶ Monitored reset ▶ Manual/automatic reset ▶ Safe separation | 751 102 | 750 102 |
| <ul style="list-style-type: none"> ▶ Single- and dual-channel wiring ▶ Detection of shorts across contacts ▶ Monitored reset ▶ Manual/automatic reset ▶ Start-up testing | 751 103 | 750 103 |
| <ul style="list-style-type: none"> ▶ Single- and dual-channel wiring ▶ Detection of shorts across contacts ▶ Monitored reset ▶ Manual/automatic reset ▶ Start-up testing ▶ Approval to EN 81-1/A3 in accordance with the Lifts Directive | <ul style="list-style-type: none"> ▶ 24 VDC _____ 751 104 ▶ 48 ... 240 VAC/DC ____ 751 134 | <ul style="list-style-type: none"> ▶ 24 VDC _____ 750 104 ▶ 48 ... 240 VAC/DC ____ 750 134 |
| <ul style="list-style-type: none"> ▶ Single- and dual-channel wiring ▶ Detection of shorts across contacts ▶ Monitored reset ▶ Manual/automatic reset ▶ Start-up testing ▶ 3 safe, diverse safety contacts ▶ Approved in accordance with the standard EN 50156-1 for electrical equipment for furnaces | <ul style="list-style-type: none"> ▶ 24 VDC _____ 751 124 ▶ 48 ... 240 VAC/DC ____ 751 154 | <ul style="list-style-type: none"> ▶ 24 VDC _____ 750 124 ▶ 48 ... 240 VAC/DC ____ 750 154 |
| <ul style="list-style-type: none"> ▶ Single- and dual-channel wiring ▶ Detection of shorts across contacts ▶ Monitored reset ▶ Manual/automatic reset ▶ Start-up testing ▶ Timer functions: delay-on de-energisation ▶ Time range: 0 ... 300 s | <ul style="list-style-type: none"> ▶ 24 VDC _____ 751 105 ▶ 24 VDC, coated version _ 751 185 ▶ 48 ... 240 VAC/DC ____ 751 135 | <ul style="list-style-type: none"> ▶ 24 VDC _____ 750 105 ▶ 48 ... 240 VAC/DC ____ 750 135 |
| <ul style="list-style-type: none"> ▶ Dual-channel wiring ▶ Detection of shorts across contacts | <ul style="list-style-type: none"> ▶ 24 VDC _____ 751 106 ▶ 48 ... 240 VAC/DC ____ 751 136 | <ul style="list-style-type: none"> ▶ 24 VDC _____ 750 106 ▶ 48 ... 240 VAC/DC ____ 750 136 |
| <ul style="list-style-type: none"> ▶ Dual-channel wiring ▶ Detection of shorts across contacts | <ul style="list-style-type: none"> ▶ 24 VDC _____ 751 126 ▶ 48 ... 240 VAC/DC ____ 751 156 | <ul style="list-style-type: none"> ▶ 24 VDC _____ 750 126 ▶ 48 ... 240 VAC/DC ____ 750 156 |



Technical documentation on safety relays PNOZsigma:

Webcode 0685

Online information at www.pilz.com

¹⁾ Height with spring-loaded terminals/plug-in screw terminals ★ Type recommended by Pilz

► Technical details – PNOZsigma



Safety relays PNOZsigma



| Type | Supply voltage (U _B) | Outputs: Voltage/current/rating | Dimensions (H x W x D) in mm |
|------------|----------------------------------|------------------------------------|------------------------------------|
| ★ PNOZ s7 | 24 VDC | DC1: 24 V/6 A/150 W | 102/98 ¹⁾ x 17.5 x 120 |
| PNOZ s7.1 | 24 VDC | DC1: 24 V/6 A/150 W | 102/98 ¹⁾ x 17.5 x 120 |
| PNOZ s7.2 | 24 VDC | DC1: 24 V/6 A/150 W | 102/98 ¹⁾ x 17.5 x 120 |
| PNOZ s8 | 24 VDC | DC1: 24 V/3 A/72 W | 102/98 ¹⁾ x 12.5 x 120 |
| PNOZ s9 | 24 VDC | DC1: 24 V/6 A/150 W | 100/96 ¹⁾ x 17.5 x 120 |
| ★ PNOZ s10 | 24 VDC | DC1: 24 V/12 A/300 W | 100/98 ¹⁾ x 45.0 x 120 |
| PNOZ s11 | 24 VDC | DC1: 24 V/6 A/150 W | 100/98 ¹⁾ x 45.0 x 120 |
| PNOZ s22 | 24 VDC | DC1: 24 V/6 A/150 W | 100/98 ¹⁾ x 22.5 x 120 |
| PNOZ s30 | 24 ... 240 VAC/DC | DC1: 24 V/4 A/100 W | 100/98 ¹⁾ x 45.0 x 120 |

| Features | Order numbers | |
|---|-------------------------|-------------------------|
| | Spring-loaded terminals | Plug-in screw terminals |
| ▶ Safe separation | 751 107 | 750 107 |
| ▶ Cascading module for connection to PNOZ s7.2 ▶ Safe separation of safety contacts ▶ LEDs for input and switch status ▶ Can also be used with other safety control devices, without a PNOZsigma base unit: one input circuit affects the output relays | 751 167 | 750 167 |
| ▶ Contact expansion module in conjunction with PNOZ s7.1 | 751 177 | 750 177 |
| - | 751 108 | 750 108 |
| ▶ Safe separation ▶ Timer functions: delay-on energisation, delay-on de-energisation, pulsing, retriggerable ▶ Time range: 0 ... 300 s | 751 109 | 750 109 |
| ▶ Safe separation | 751 110 | 750 110 |
| ▶ Safe separation | 751 111 | 750 111 |
| ▶ Two safety contacts that can be controlled separately ▶ Contact expansion for the speed monitor PNOZ s30 and the base units PNOZ mm0.1p/mm0.2p of the configurable safety relays PNOZmulti Mini | 751 132 | 750 132 |
| ▶ Safe monitoring of standstill, speed, direction of rotation and shear pin breakage ▶ Parameters for device functions can be freely set ▶ Parameters are entered via rotary knob (push and turn) in conjunction with a monochrome display ▶ Set parameters are saved on a chip card ▶ Integrated display shows the set limit values/parameters as well as the current speed ▶ Tolerances can be freely set for each limit value ▶ Axis position monitoring is available as an option with the standstill function ▶ Advance warning of shutdown when a certain threshold is reached | 751 330 | 750 330 |



¹⁾ Height with spring-loaded terminals/plug-in screw terminals

★ Type recommended by Pilz

Technical documentation on safety relays PNOZsigma:

Webcode 0685

Online information at www.pilz.com

► Safety relays PNOZ X

Safety relays from the product range PNOZ X are proven through their reliability and robustness and have developed a wide application range in the most varied of safety applications. PNOZ is the most widely used safety relay in the world. One PNOZ is used per safety function.



PNOZ X1P

PNOZ X3P

PNOZ X9P

Customised safety for each application

Its technical features are based on voltage-free, electromechanical contacts in 2 relay technology. Sizes vary from 22.5 to 90 mm, the number of contacts from two to eight. Whatever your safety requirement – PNOZ X has already proved itself a million times over in the rugged everyday industrial environment. Why not take advantage!

Your benefits at a glance

- Technology proven over many years of use
- Huge selection of products
- For all safety functions such as monitoring E-STOPS, safety gates, light beam devices, muting, pressure sensitive mats, two-hand control and much more
- Delayed and instantaneous contact expansion modules, safe timers, safe monitoring relays for standstill, speed and other functions
- Excellent price/performance ratio
- Rapid commissioning thanks to plug-in terminals
- Maximum safety with minimum space requirement
- Complete solution comprising evaluation devices, compatible sensor technology, control and signal devices
- Low storage costs thanks to universal power supply and plug-in terminals



Keep up-to-date
on safety relays
PNOZ X:

Webcode 5225



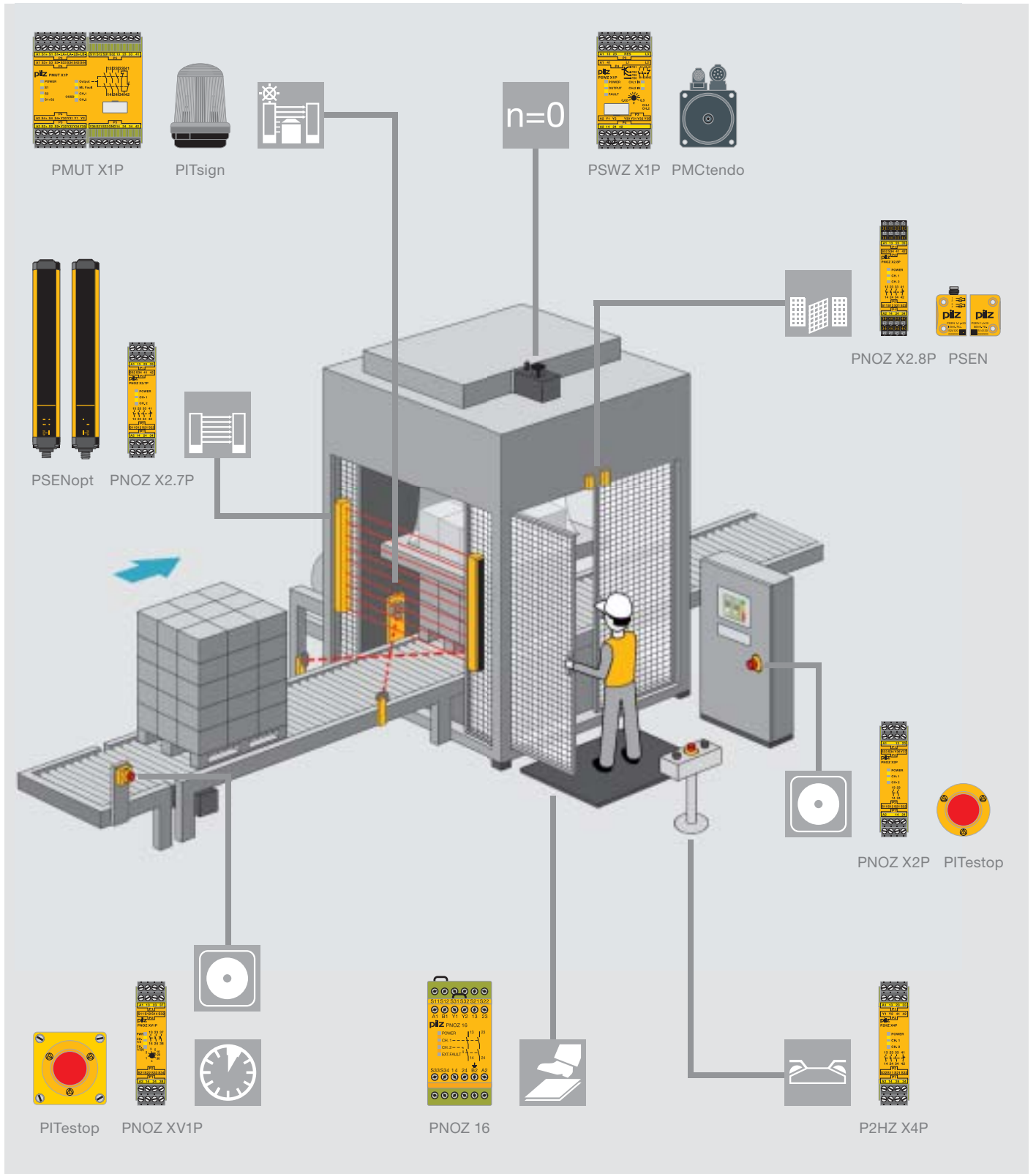



Online information
at www.pilz.com







Example: using safety relays PNOZ X on a packaging machine.

► Selection guide – PNOZ X

Safety relays PNOZ X

| Type | Application | | | | | |
|--------------|---|---|---|---|---|--|
| |  |  |  |  |  |  |
| PNOZ X1P | ◆ | ◆ | | | | |
| PNOZ X2P | ◆ | ◆ | | | | |
| PNOZ X2.7P | ◆ | ◆ | ◆ | | | |
| PNOZ X2.8P | ◆ | ◆ | ◆ | | | |
| PNOZ X3P | ◆ | ◆ | ◆ | | | |
| PNOZ X7P | ◆ | ◆ | | | | |
| PNOZ X8P | ◆ | ◆ | ◆ | | | |
| PNOZ X9P | ◆ | ◆ | ◆ | | | |
| PNOZ X10.11P | ◆ | ◆ | ◆ | | | |
| PNOZ X11P | ◆ | ◆ | ◆ | | | |
| PNOZ XV1P | ◆ | ◆ | ◆ | | | |
| PNOZ XV3P | ◆ | ◆ | ◆ | | | |
| PNOZ XV3.1P | ◆ | ◆ | ◆ | | | |
| PMUT X1P | ◆ | | ◆ | ◆ | | |
| P2HZ X1P | | | | | ◆ | EN 574, Type IIIC |
| P2HZ X4P | | | | | ◆ | EN 574, Type IIIC |
| PSWZ X1P | | | | | | ◆ |
| PZE X4P | Contact expansion | | | | | |

| Performance Level (PL) – EN ISO 13849-1 | Safety Integrity Level (SIL) CL – claim limit in accordance with IEC 62061 | Output contacts | | | | Housing width in mm |
|---|--|---|---|---|---|---------------------|
| | | Safe | | Non-safe | | |
| | |  |  |  |  | |
| e | 3 | 3 | - | 1 | - | 22.5 |
| e | 3 | 2 | - | - | - | 22.5 |
| e | 3 | 3 | - | 1 | - | 22.5 |
| e | 3 | 3 | - | 1 | - | 22.5 |
| e | 3 | 3 | - | 1 | 1 | 45.0 |
| e | 3 | 2 | - | - | - | 22.5 |
| e | 3 | 3 | - | 2 | 2 | 45.0 |
| e | 3 | 7 | - | 2 | 2 | 90.0 |
| e | 3 | 6 | - | 4 | - | 90.0 |
| e | 3 | 7 | - | 1 | 2 | 90.0 |
| e (d) ¹⁾ | 3 | 2 | 1 | - | - | 22.5 |
| e (d) ¹⁾ | 3 | 3 | 2 | - | - | 45.0 |
| e (d) ¹⁾ | 3 | 3 | 2 | 1 | - | 90.0 |
| e | 3 | 3 | - | 1 | 5 | 90.0 |
| e | 3 | 3 | - | 1 | 2 | 45.0 |
| e | 3 | 3 | - | 1 | - | 22.5 |
| e | 3 | 2 | - | 1 | 1 | 45.0 |
| e | 3 | 4 | - | - | - | 22.5 |

¹⁾ Value applies for instantaneous (delayed) safety contacts

Technical documentation on safety relays PNOZ X:

 Webcode 0685

Online information at www.pilz.com

► Technical details – PNOZ X

Safety relays PNOZ X



PNOZ X1P



PNOZ X2.8P



PNOZ X3P



PNOZ X9P

| Type | Supply voltage (U _B) | Outputs: Voltage/current/rating | Dimensions (H x W x D) in mm |
|----------------------------|---|------------------------------------|------------------------------------|
| ★ PNOZ X1P | 24 VDC | DC1: 24 V/6 A/150 W | 101/94 ¹⁾ x 22.5 x 121 |
| PNOZ X2P | <ul style="list-style-type: none"> ▶ 24 VAC/DC ▶ 48 ... 240 VAC/DC | DC1: 24 V/6 A/150 W | 101/94 ¹⁾ x 22.5 x 121 |
| ★ PNOZ X2.7P PNOZ X2.8P | <ul style="list-style-type: none"> ▶ 24 VAC/DC ▶ 24 ... 240 VAC/DC | DC1: 24 V/6 A/150 W | 101/94 ¹⁾ x 22.5 x 121 |
| PNOZ X3P | <ul style="list-style-type: none"> ▶ 24 VAC/DC ▶ 24 ... 240 VAC/DC | DC1: 24 V/8 A/200 W | 101/94 ¹⁾ x 45 x 121 |
| PNOZ X7P | <ul style="list-style-type: none"> ▶ 24 VAC/DC ▶ 110 ... 120, ▶ 230 ... 240 VAC | DC1: 24 V/6 A/150 W | 101/94 ¹⁾ x 22.5 x 121 |
| PNOZ X8P | <ul style="list-style-type: none"> ▶ 24 VDC ▶ 24, 110, 115, ▶ 120, 230 VAC | DC1: 24 V/8 A/200 W | 101/94 ¹⁾ x 45 x 121 |
| ★ PNOZ X9P | <ul style="list-style-type: none"> ▶ 12 VDC ▶ 24 VDC, ▶ 100 ... 240 VAC | DC1: 24 V/8 A/200 W | 101/94 ¹⁾ x 90 x 121 |
| PNOZ X11P | <ul style="list-style-type: none"> ▶ 24 VDC, 24 VAC ▶ 110 ... 120, ▶ 230 ... 240 VAC | DC1: 24 V/8 A/200 W | 101/94 ¹⁾ x 90 x 121 |

| Features | Order numbers | |
|---|--|--|
| | Spring-loaded terminals | Plug-in screw terminals |
| ▶ 1-channel operation | 787 100 | 777 100 |
| ▶ 2-channel operation with detection of shorts across contacts ▶ Automatic or monitored reset can be selected | ▶ 24 VAC/DC _____ 787 303 ▶ 48 ... 240 VAC/DC _____ 787 307 | ▶ 24 VAC/DC _____ 777 303 ▶ 48 ... 240 VAC/DC _____ 777 307 |
| ▶ 2-channel operation with or without detection of shorts across contacts ▶ PNOZ X2.7P: Monitored reset ▶ PNOZ X2.7P: Automatic reset | ▶ PNOZ X2.7P C - 24 VAC/DC _____ 787 305 - 24 ... 240 VAC/DC _____ 787 306 ▶ PNOZ X2.8P C - 24 VAC/DC _____ 787 301 - 24 ... 240 VAC/DC _____ 787 302 | ▶ PNOZ X2.7P C - 24 VAC/DC _____ 777 305 - 24 ... 240 VAC/DC _____ 777 306 ▶ PNOZ X2.8P C - 24 VAC/DC _____ 777 301 - 24 ... 240 VAC/DC _____ 777 302 |
| ▶ Dual-channel wiring, with or without detection of shorts across contacts ▶ Monitored or automatic reset can be selected ▶ 1 semiconductor output ▶ Safety gate function with N/C/N/O combination | ▶ 24 VAC/DC _____ 787 310 ▶ 24 ... 240 VAC/DC _____ 787 313 | ▶ 24 VAC/DC _____ 777 310 ▶ 24 ... 240 VAC/DC _____ 777 313 |
| ▶ 1-channel operation | ▶ 24 VAC/DC _____ 787 059 ▶ More available on request | ▶ 24 VAC/DC _____ 777 059 ▶ More available on request |
| ▶ 2-channel operation with or without detection of shorts across contacts ▶ Monitored or automatic reset can be selected ▶ 2 semiconductor outputs | ▶ 24 VAC _____ 787 770 ▶ 24 VDC _____ 787 760 ▶ More available on request | ▶ 24 VAC _____ 777 770 ▶ 24 VDC _____ 777 760 ▶ More available on request |
| ▶ Dual-channel wiring, with or without detection of shorts across contacts ▶ Monitored or automatic reset can be selected ▶ 2 semiconductor outputs | ▶ 24 VDC _____ 787 609 ▶ 24 VDC, 100 ... 240 VAC _____ 787 606 | ▶ 12 VDC _____ 777 607 ▶ 24 VDC _____ 777 609 ▶ 24 VDC, 100 ... 240 VAC _____ 777 606 |
| ▶ Dual-channel wiring, with or without detection of shorts across contacts ▶ Monitored or automatic reset can be selected ▶ 2 semiconductor outputs | ▶ 24 VDC, 24 VAC _____ 787 080 ▶ 110 ... 120 VAC _____ 787 083 ▶ 230 ... 240 VAC _____ 787 086 | ▶ 24 VDC, 24 VAC _____ 777 080 ▶ 110 ... 120 VAC, 24 VDC _____ 777 083 ▶ 230 ... 240 VAC, 24 VDC _____ 777 086 |



¹⁾ Height with spring-loaded terminals/plug-in screw terminals

★ Type recommended by Pilz

Technical documentation on safety relays PNOZ X:

Webcode 0685

Online information at www.pilz.com

► Technical details – PNOZ X

Safety relays PNOZ X



PNOZ XV1P



PNOZ XV3P



PMUT X1P



P2HZ X4P

| Type | Supply voltage (U _B) | Outputs: Voltage/current/rating | Dimensions (H x W x D) in mm |
|-------------|---|------------------------------------|------------------------------------|
| PNOZ XV1P | 24 VDC | DC1: 24 V/5 A/125 W | 101/94 ¹⁾ x 22.5 x 121 |
| ★ PNOZ XV3P | 24 VDC | DC1: 24 V/8 A/200 W | 101/94 ¹⁾ x 45 x 121 |
| PNOZ XV3.1P | <ul style="list-style-type: none"> ▶ 24 VDC ▶ 24 ... 240 VAC/DC | DC1: 24 V/8 A/200 W | 101/94 ¹⁾ x 90 x 121 |
| PMUT X1P | 24 VDC | DC1: 24 V/8 A/200 W | 101/94 ¹⁾ x 90 x 121 |
| ★ P2HZ X1P | <ul style="list-style-type: none"> ▶ 24 VDC ▶ 24, 42, 48, 110, 115, 120, 230, 240 VAC | DC1: 24 V/5 A/125 W | 101/94 ¹⁾ x 45 x 121 |
| P2HZ X4P | 24 VAC/DC | DC1: 24 V/5 A/125 W | 101/94 ¹⁾ x 22.5 x 121 |
| PSWZ X1P | 24 ... 240 VAC/DC | DC1: 24 V/6 A/150 W | 101/94 ¹⁾ x 45 x 121 |
| PZE X4P | 24 VDC | DC1: 24 V/6 A/150 W | 101/94 ¹⁾ x 22.5 x 121 |

| Features | Order numbers | |
|--|--|--|
| | Spring-loaded terminals | Plug-in screw terminals |
| <ul style="list-style-type: none"> ▶ Dual-channel wiring, with or without detection of shorts across contacts ▶ Monitored or automatic reset can be selected | <ul style="list-style-type: none"> ▶ 0.1 ... 3 s _____ 787 601 ▶ 1 ... 30 s _____ 787 602 | <ul style="list-style-type: none"> ▶ 0.1 ... 3 s _____ 777 601 ▶ 1 ... 30 s _____ 777 602 |
| <ul style="list-style-type: none"> ▶ Dual-channel wiring, with or without detection of shorts across contacts ▶ Monitored or automatic reset can be selected | <ul style="list-style-type: none"> ▶ 3 s _____ 787 512 ▶ 30 s _____ 787 510 ▶ More available on request | <ul style="list-style-type: none"> ▶ 3 s _____ 777 512 ▶ 30 s _____ 777 510 ▶ More available on request |
| <ul style="list-style-type: none"> ▶ Dual-channel wiring, with or without detection of shorts across contacts ▶ Monitored or automatic reset can be selected ▶ Universal power supply 24 ... 240 VAC/DC | <ul style="list-style-type: none"> ▶ 3 s selectable, 24 ... 240 VAC/DC _____ 787 532 ▶ 30 s selectable, 24 ... 240 VAC/DC _____ 787 530 ▶ More available on request | <ul style="list-style-type: none"> ▶ 3 s selectable, 24 ... 240 VAC/DC _____ 777 532 ▶ 30 s selectable, 24 ... 240 VAC/DC _____ 777 530 ▶ More available on request |
| <ul style="list-style-type: none"> ▶ Up to 4 muting sensors ▶ Monitoring and switching muting lamps ▶ Parallel and sequential muting ▶ Simultaneity monitoring ▶ 5 semiconductor outputs ▶ Reset input ▶ Override function via key switch in the case of a fault ▶ LED status indicators | 788 010 | 778 010 |
| <ul style="list-style-type: none"> ▶ 2 semiconductor outputs | <ul style="list-style-type: none"> ▶ 24 VDC _____ 787 340 ▶ More available on request | <ul style="list-style-type: none"> ▶ 24 VDC _____ 777 340 ▶ More available on request |
| <ul style="list-style-type: none"> ▶ 22.5 mm width | <ul style="list-style-type: none"> ▶ 24 VAC _____ 787 354 ▶ 24 VDC _____ 787 355 | <ul style="list-style-type: none"> ▶ 24 VAC _____ 777 354 ▶ 24 VDC _____ 777 355 |
| <ul style="list-style-type: none"> ▶ Safe standstill monitoring ▶ 1 or 2-channel operation ▶ No external components required ▶ Fault signal if simultaneity time is exceeded ▶ Reset input ▶ Detects open circuits | <ul style="list-style-type: none"> ▶ UM: 0.5 V _____ 787 949 ▶ UM: 3 V _____ 787 950 | <ul style="list-style-type: none"> ▶ UM: 0.5 V _____ 777 949 ▶ UM: 3 V _____ 777 950 |
| <ul style="list-style-type: none"> ▶ 1-channel operation | 787 585 | 777 585 |



¹⁾ Height with spring-loaded terminals/plug-in screw terminals

★ Type recommended by Pilz

Technical documentation on safety relays PNOZ X:

Webcode 0685

Online information at www.pilz.com

► Safety relays PNOZcompact

The safety relay is optimised for functionality and can be used in all areas of engineering. In series machine production in particular, the use of the PNOZcompact has many advantages thanks to its concentrated functionality: So high-volume projects with a high degree of standardisation can be implemented economically. Opt for a safety relay PNOZ – the original, the synonym for safety relays.



PNOZ c1

Square, simple, yellow

Do you wish to safely monitor an emergency stop device or a safety gate? Is your application intended to achieve Performance Level (PL) e of EN ISO 13849-1, Safety Integrity Level (SIL) CL claim limit 3 of IEC 62061? Do you require a unit that covers the basic functionalities and provides three safety contacts and an auxiliary contact for your application? Is it important to you to save time through simple installation and maintenance? Then we have the right solution for you – the safety relay PNOZcompact – square, simple, yellow!

Safety relays with compact dimensions

PNOZ c1, the first unit in the product range, is 105 mm high, 100 mm deep and a compact 22.5 mm wide. Push-in spring terminals fixed on the safety relay can be wired without the need for tools. A block diagram with connection example is printed on the side of the unit and is a great help.



Keep up-to-date on safety relays PNOZcompact:



Webcode 8180

Online information at www.pilz.com

Selection guide – Safety relays PNOZcompact



PNOZ c1

| Type | Application area | Dimensions (H x W x D) in mm |
|---------|--------------------------------------|--------------------------------|
| PNOZ c1 | E-STOP relay and safety gate monitor | 105 ¹⁾ x 22.5 x 100 |

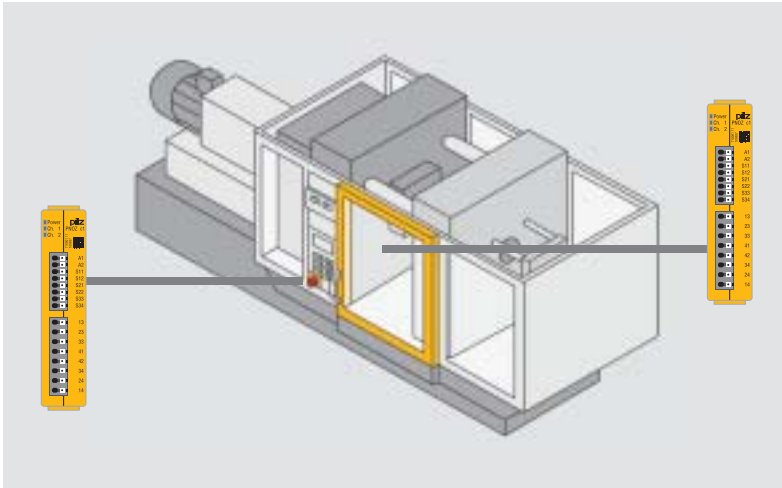

Your benefits at a glance

- ▶ Save space in the control cabinet thanks to the compact design
- ▶ Save time through simple installation and maintenance: push-in spring terminals fixed on the device can be connected without tools
- ▶ Tool-free assembly: simply attach the device to the top hat rail

Monitor an E-STOP or safety gate – in any application – safe, simple, compact. Use one safety relay per safety function.



A block diagram with connection example is printed on the side of the PNOZ c1.

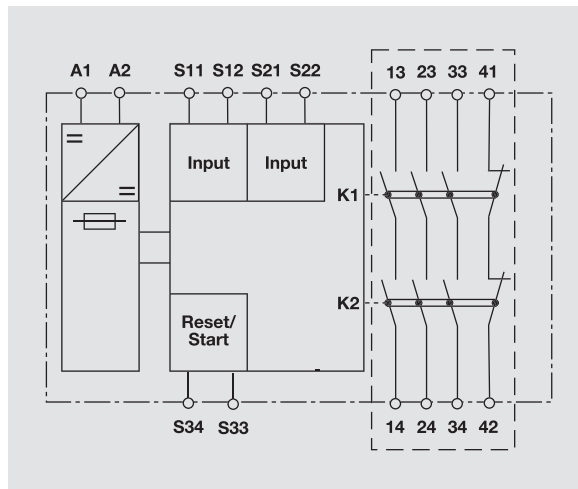

Features

- ▶ PL e of EN ISO 13849-1, Safety Integrity Level (SIL) CL claim limit in accordance with IEC 62061
- ▶ 3 safety contacts/1 auxiliary contact (3 N/O/1 N/C)
- ▶ Supply voltage (U_B): 24 VDC
- ▶ Dual-channel wiring with detection of shorts across contacts, manual or automatic reset
- ▶ LEDs to display operating voltage and switch status
- ▶ Spring-loaded terminals fixed on the device
- ▶ Stop category: 0
- ▶ Outputs (voltage/current): DC1: 24 V/6 A, DC13: 24 V/5 A, AC15: 230 V/5 A

Order numbers

710001



¹⁾ Height incl. spring clip

► Safety relays PNOZelog

Ideal for monitoring up to four safety functions, the innovative PNOZelog product range combines the experience of the electromechanical safety relays with the benefits of modern electronics.



PNOZ e1.1p

PNOZ e6.1p

Extended diagnostics, easy to link

Wear-resistance, safety, long service life and high availability ensure it is cost-effective to use. What's more, the PNOZelog can be linked through logic AND/OR operations. Diagnostics on the PNOZelog have been extended. Power-up tests, self-checking and runtime tests guarantee maximum safety.

Complete safety functions through logic function operations

Units in the PNOZelog product range can be linked via logic operations to form complete safety functions. AND/OR operations are both available. The use of logic functions means that the output requires no additional wiring. Both outputs on the PNOZelog units are freely available. As many units as necessary can be connected in series – ideal for monitoring up to four safety functions.

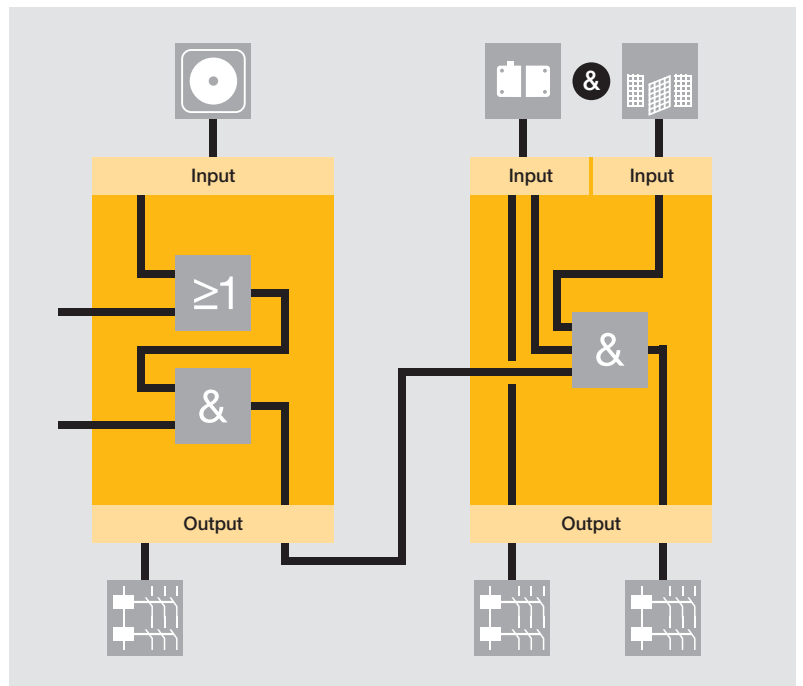

Less wiring due to linkable outputs.

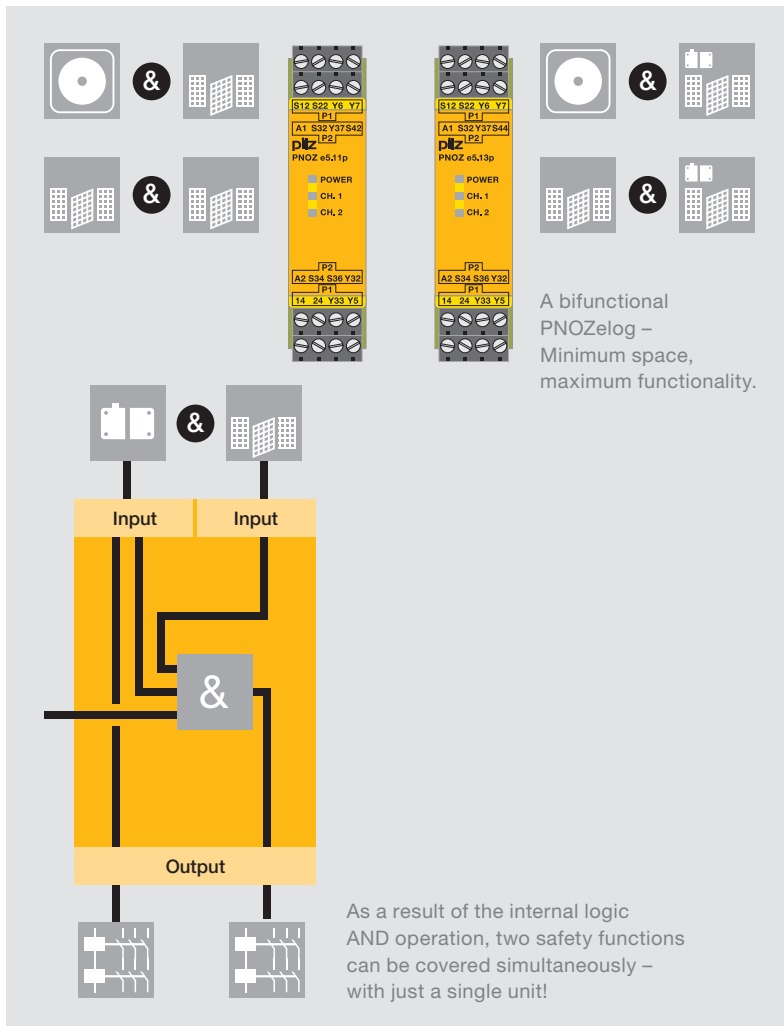

Your benefits at a glance

- ▶ Less wiring thanks to simple logic operations (AND/OR)
- ▶ High availability thanks to extended diagnostics
- ▶ Consistent use of semi-conductor technology means no maintenance is necessary – there are no malfunctions due to contact welding, contamination, bounce or burning
- ▶ Continuous self-checks provide the highest level of safety – fault detection is not linked to the on/off cycle
- ▶ Long service life, even with frequent operations or cyclical functions
- ▶ Safe switching operations even on the smallest of loads
- ▶ Rapid commissioning thanks to plug-in terminals; no additional tools are required
- ▶ Complete solution comprising evaluation devices, compatible sensor technology and control and signal devices



PNOZeLog can be linked through logic AND/OR operations.

“2-in-1” – the bifunctional PNOZeLog

Do you require E-STOP or safety gate monitoring within a compact safety unit? Monitor two safety functions simultaneously with just a single unit. You save on wiring. With a width of just 22.5 mm, the space requirement within the control cabinet is reduced to a minimum. Maximum functionality is achieved through the internal logic AND operation. Each safety function has a separate signal output.





- ▶ PNOZ e5.11p simultaneously monitors an E-STOP/safety gate combination or two safety gates
- ▶ The PNOZ e5.13p can also be connected to the safety switches PSENmag







Keep up-to-date on safety relays PNOZeLog:

 Webcode 0209

Online information at www.pilz.com

► Selection guide – PNOZelog

| Safety relays PNOZelog | | | | | | |
|-------------------------|---|---|---|---|---|---|
| Type | Application | | | | | Performance Level (PL) – EN ISO 13849-1 |
| |  |  |  |  |  | |
| PNOZ e1p | ◆ | ◆ | ◆ | | | e |
| PNOZ e1.1p | ◆ | ◆ | ◆ | | | e |
| PNOZ e1vp | ◆ | ◆ | ◆ | | | e |
| PNOZ e2.1p | | | | ◆ | EN 574, Type IIIC | e |
| PNOZ e2.2p | | | | ◆ | EN 574, Type IIIA | e |
| PNOZ e3.1p | | ◆ | | | | e |
| PNOZ e3vp | | ◆ | | | | e |
| PNOZ e4.1p | | | | | ◆ | d |
| PNOZ e4vp | | | | | ◆ | d |
| PNOZ e5.11p | ◆ | ◆ | | | | e |
| PNOZ e5.13p | ◆ | ◆ | | | | e |
| PNOZ e6.1p | ◆ | ◆ | ◆ | | | e |
| PNOZ e6vp | ◆ | ◆ | ◆ | | | e |
| PNOZ e7p | ◆ | ◆ | ◆ | | | e |
| PNOZ e8.1p with PLID d1 | ◆ | ◆ | | | | d |

| Safety Integrity Level (SIL) CL – claim limit in accordance with IEC 62061 | Semiconductor outputs | | Relay outputs | | Logic operations | | |
|--|---|---|---|---|--|---|---|
| | Safe | | Non-safe | Safe | | | |
| |  |  |  |  |  |  |  |
| 3 | 2 | | 1 | - | - | | |
| 3 | 2 | | 1 | - | - | ◆ | ◆ |
| 3 | 2 | ◆ | 1 | - | - | ◆ | ◆ |
| 3 | 2 | | 1 | - | - | ◆ | ◆ |
| 1 | 2 | | 1 | - | - | ◆ | ◆ |
| 3 | 2 | | 1 | - | - | ◆ | ◆ |
| 3 | 2 | ◆ | 1 | - | - | ◆ | ◆ |
| 2 | 2 | | 1 | - | - | ◆ | ◆ |
| 2 | 2 | ◆ | 1 | - | - | ◆ | ◆ |
| 3 | 2 | | 2 | - | - | ◆ ¹⁾ | |
| 3 | 2 | | 2 | - | - | ◆ ¹⁾ | |
| 3 | 2 | | 1 | 4 | - | ◆ | ◆ |
| 3 | 2 | ◆ | 1 | 4 | - | ◆ | ◆ |
| 3 | 2 | | 1 | - | - | ◆ | |
| 2 | 2 | | 2 | - | - | ◆ | ◆ |

¹⁾ Also AND-linked internally

Technical
documentation
on safety relays
PNOZelog:

 Webcode 0685

Online information
at www.pilz.com

► Technical details – PNOZelog

Safety relays PNOZelog



| Type | Application area | Outputs | Outputs: Voltage/ current/ rating |
|--|---|--|--|
| PNOZ e1p | Emergency stop, safety gate and light beam monitoring | Using semiconductor technology: ▶ 2 safety outputs ▶ 1 auxiliary output, can be switched to a diagnostic output ▶ 2 test pulse outputs | 24 VDC/ 2 A/50 W |
| ★ PNOZ e1.1p | Emergency stop, safety gate and light beam monitoring | Using semiconductor technology: ▶ 2 safety outputs ▶ 1 auxiliary output, can be switched to a diagnostic output ▶ 2 test pulse outputs | 24 VDC/ 2 A/50 W |
| ★ PNOZ e1vp | Emergency stop, safety gate and light beam monitoring | Using semiconductor technology: ▶ 2 safety outputs delayed/instantaneous, delay-on de-energisation selectable ▶ 1 auxiliary output, can be switched to a diagnostic output ▶ 2 test pulse outputs | 24 VDC/ 2 A/50 W |
| PNOZ e2.1p PNOZ e2.2p | PNOZ e2.1p: In accordance with EN 574, requirement class IIIC; PNOZ e2.2p: In accordance with EN 574, requirement class IIIA: Two-hand monitoring | Using semiconductor technology: ▶ 2 safety outputs ▶ 1 auxiliary output, can be switched to a diagnostic output ▶ 2 test pulse outputs | 24 VDC/ 2 A/50 W |
| ★ PNOZ e3.1p | Safety gate monitoring | Using semiconductor technology: ▶ 2 safety outputs ▶ 1 auxiliary output, can be switched to a diagnostic output ▶ 2 test pulse outputs | 24 VDC/ 2 A/50 W |
| PNOZ e3vp | Safety gate monitoring | Using semiconductor technology: ▶ 2 safety outputs delayed/instantaneous, delay-on de-energisation selectable ▶ 1 auxiliary output, can be switched to a diagnostic output ▶ 2 test pulse outputs | 24 VDC/ 2 A/50 W |
| PNOZ e4.1p | Evaluation device for safety mats | Using semiconductor technology: ▶ 2 safety outputs ▶ 1 auxiliary output, can be switched to a diagnostic output ▶ 2 test pulse outputs | 24 VDC/ 2 A/50 W |

Common features

- ▶ Supply voltage (U_B): 24 VDC
- ▶ Dimensions (H x W x D): 101/94¹⁾ x 22.5 x 121 mm

| Features | Order numbers | |
|--|--|--|
| | Spring-loaded terminals | Plug-in screw terminals |
| <ul style="list-style-type: none"> ▶ Evaluation device for non-contact, coded safety switches PSENcode ▶ Monitored or automatic reset can be selected ▶ Selectable monitoring of shorts across contacts | 784 130 | 774 130 |
| <ul style="list-style-type: none"> ▶ Evaluation device for non-contact, coded safety switches PSENcode ▶ Monitored or automatic reset can be selected ▶ One AND and one OR input for logic AND/OR connections between several PNOZelog units ▶ Selectable monitoring of shorts across contacts | 784 133 | 774 133 |
| <ul style="list-style-type: none"> ▶ Evaluation device for non-contact, coded safety switches PSENcode ▶ Monitored or automatic reset can be selected ▶ One AND and one OR input for logic AND/OR connections between several PNOZelog units ▶ Selectable monitoring of shorts across contacts | <ul style="list-style-type: none"> ▶ 10 s _____ 784 131 ▶ 300 s _____ 784 132 | <ul style="list-style-type: none"> ▶ 10 s _____ 774 131 ▶ 300 s _____ 774 132 |
| <ul style="list-style-type: none"> ▶ One AND and one OR input for logic AND/OR connections between several PNOZelog units ▶ Shorts across contacts are monitored via two test pulse outputs ▶ Status display ▶ Feedback loop for monitoring external contactors | <ul style="list-style-type: none"> ▶ PNOZ e2.1p _____ 784 136 ▶ PNOZ e2.2p _____ 784 135 | <ul style="list-style-type: none"> ▶ PNOZ e2.1p _____ 774 136 ▶ PNOZ e2.2p _____ 774 135 |
| <ul style="list-style-type: none"> ▶ Evaluation device for position switches and for non-contact, magnetic safety switches PSENm_{ag} (Series 2) ▶ Monitored or automatic reset can be selected ▶ One AND and one OR input for logic AND/OR connections between several PNOZelog units ▶ Selectable monitoring of shorts across contacts | 784 139 | 774 139 |
| <ul style="list-style-type: none"> ▶ Evaluation device for position switches and for non-contact, magnetic safety switches PSENm_{ag} (Series 2) ▶ Monitored or automatic reset can be selected ▶ One AND and one OR input for logic AND/OR connections between several PNOZelog units ▶ Selectable monitoring of shorts across contacts | <ul style="list-style-type: none"> ▶ 10 s _____ 784 137 ▶ 300 s _____ 784 138 | <ul style="list-style-type: none"> ▶ 10 s _____ 774 137 ▶ 300 s _____ 774 138 |
| <ul style="list-style-type: none"> ▶ Used to connect Mayser safety mats, type: SM/BK ▶ Suitable for controlling PSS/SafetyBUS p/PNOZmulti ▶ One AND and one OR input for logic AND/OR connections between several PNOZelog units ▶ With or without reset function | 784 180 | 774 180 |



¹⁾ Height with spring-loaded terminals/plug-in screw terminals

★ Type recommended by Pilz

Technical documentation on safety relays PNOZelog:

Webcode 0685

Online information at www.pilz.com

► Technical details – PNOZelog

Safety relays PNOZelog



PNOZ e5.11p



PNOZ e5.13p



PNOZ e6.1p



PNOZ e7p

| Type | Application area | Outputs | Outputs: Voltage/ current/ rating |
|----------------------|--|---|--|
| PNOZ e4vp | Evaluation device for safety mats | Using semiconductor technology: ▶ 2 safety outputs delayed/instantaneous, delay-on de-energisation selectable ▶ 1 auxiliary output, can be switched to a diagnostic output ▶ 2 test pulse outputs | 24 VDC/ 1.5 A/40 W |
| PNOZ e5.11p | Combined unit for monitoring emergency switching off relay and/or safety gate, AND-linked internally | Using semiconductor technology: ▶ 2 safety outputs ▶ 2 auxiliary outputs | 24 VDC/ 1.5 A/40 W |
| ★ PNOZ e5.13p | Combined unit for monitoring emergency switching off relay and/or safety gate, AND-linked internally | Using semiconductor technology: ▶ 2 safety outputs ▶ 2 auxiliary outputs | 24 VDC/ 1.5 A/40 W |
| PNOZ e6.1p | Emergency stop, safety gate and light beam monitoring | Using semiconductor technology: ▶ 2 safety outputs ▶ 1 auxiliary output, can be switched to a diagnostic output ▶ 2 test pulse outputs Relay outputs: ▶ 4 safety contacts (N/O) | Outputs using semiconductor technology: 24 VDC/4 A/50 W Relay outputs: DC1: 24 V/6 A/150 W |
| PNOZ e6vp | Emergency stop, safety gate and light beam monitoring | Using semiconductor technology: ▶ 2 safety outputs delayed/instantaneous, delay-on de-energisation selectable ▶ 1 auxiliary output, can be switched to a diagnostic output ▶ 2 test pulse outputs Relay outputs: ▶ 4 safety contacts (N/O) | Outputs using semiconductor technology: 24 V/4 A/50 W Relay outputs: DC1: 24 V/6 A/150 W |
| PNOZ e7p | Safety light beam devices, emergency stop pushbuttons, safety gate limit switches, reset buttons | Using semiconductor technology: ▶ 2 safety outputs ▶ 2 test pulse outputs ▶ 1 auxiliary output | Outputs using semiconductor technology: 24 VDC |
| PNOZ e8.1p | Evaluation device for safe line inspection with PLID d1 | Using semiconductor technology: ▶ 2 safety outputs ▶ 2 auxiliary outputs | 24 VDC/ 1.5 A/40 W |

Common features

- ▶ Supply voltage (U_B): 24 VDC
- ▶ Dimensions (H x W x D): 101/94¹⁾ x 22.5 x 121 mm,
PNOZ e6.1p and PNOZ e6vp: 101/94¹⁾ x 45 x 121 mm

| Features | Order numbers | |
|---|-------------------------|---|
| | Spring-loaded terminals | Plug-in screw terminals |
| <ul style="list-style-type: none"> ▶ Used to connect Mayser safety mats, type: SM/BK ▶ Suitable for controlling PSS/SafetyBUS p/PNOZmulti ▶ One AND and one OR input for logic AND/OR connections between several PNOZelog units ▶ With or without reset function | 10 s _____ 784 181 | <ul style="list-style-type: none"> ▶ 10 s _____ 774 181 ▶ 300 s _____ 774 182 |
| <ul style="list-style-type: none"> ▶ 2 safety functions in one unit, AND-linked internally ▶ Evaluation device for position switches and non-contact, coded safety switches PSENcode ▶ One AND input for logic AND operations between several PNOZelog units ▶ Monitored or automatic reset can be selected | 784 190 | 774 190 |
| <ul style="list-style-type: none"> ▶ 2 safety functions in one unit, AND-linked internally ▶ Evaluation device for position switches, non-contact safety switches PSENcode and PSENmag (Series 2.X) ▶ Monitored or automatic reset can be selected ▶ One AND input for logic AND operations between several PNOZelog units | 784 191 | 774 191 |
| <ul style="list-style-type: none"> ▶ Connection option for E-STOP pushbuttons, safety gate limit switches, reset buttons, safety mats and safe edges made by Haake, proximity switch evaluation devices ▶ Monitored or automatic reset can be selected ▶ One AND and one OR input for logic AND/OR connections between several PNOZelog units ▶ Selectable monitoring of shorts across contacts | 784 192 | 774 192 |
| <ul style="list-style-type: none"> ▶ Connection option for E-STOP pushbuttons, safety gate limit switches, reset buttons, safety mats and safe edges made by Haake, proximity switch evaluation devices ▶ Monitored or automatic reset can be selected ▶ One AND and one OR input for logic AND/OR connections between several PNOZelog units ▶ Selectable monitoring of shorts across contacts | 784 193 | 774 193 |
| <ul style="list-style-type: none"> ▶ Connection option for E-STOP pushbuttons, safety gate limit switches, reset buttons, safety mats and safe edges made by Haake, proximity switch evaluation devices ▶ Monitored or automatic reset can be selected ▶ One AND and one OR input for logic AND/OR connections between several PNOZelog units ▶ Selectable monitoring of shorts across contacts | 784 197 | 774 197 |
| <ul style="list-style-type: none"> ▶ Monitored or automatic reset can be selected ▶ Monitoring of shorts across contacts can be selected for E-STOP application | 784 198 | 774 198 |



¹⁾ Height with spring-loaded terminals/plug-in screw terminals

★ Type recommended by Pilz

Technical documentation on safety relays PNOZelog:

Webcode 0685

Online information at www.pilz.com

► Safe line inspection devices PLIDdys – Safe pow

The safe line inspection devices PLIDdys provides safe power-up on two-wire connections, providing maximum safety on long cable routes.



PLID d1 + PNOZ e8.1p

With PLIDdys, unintended power-up or plant start-up can be excluded in the event of an error. This is particularly beneficial on interlinked plants or on plant sections distributed over a wide area, which may not always be clearly visible. An extremely compact design means it can be easily retrofitted into an existing plant and PLIDdys can be incorporated into the sensor or switch, for example. In combination with the evaluation device PNOZ e8.1p, the line inspection device PLIDdys is the optimum solution for safe cables/connections.



Selection guide – Safe line inspection devices PLIDdys



PLID d1

| Type | Application area |
|-------------------|---|
| PLID d1 | Line inspection device PLIDdys in combination with the evaluation device PNOZ e8.1p |
| PNOZ e8.1p | Evaluation device for safe line inspection with PLID d1 |

er-up in conjunction with PNOZ e8.1p

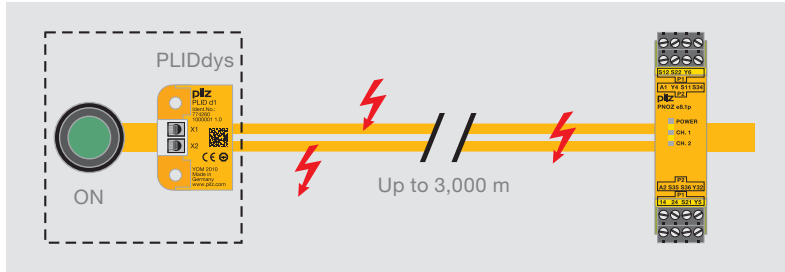

Monitoring for potential wiring errors and protection against power-up in the event of an error.

Example applications of the line inspection device PLIDdys

Safe inspection of long cable routes in critical environments

- ▶ Cable cars, lift systems
- ▶ Conveyor belts in open cast mining or underground
- ▶ Tunnel boring machinery
- ▶ Press lines
- ▶ Fairground rides
- ▶ Drag chain applications
- ▶ Interlinked/distributed plant sections

Your benefits at a glance

- ▶ All potential wiring errors are detected through constant line inspection by PLIDdys, no need for customised tests
- ▶ PLIDdys can be looped into the existing wiring, so few additional costs
- ▶ Easy to integrate into existing plants thanks to its small dimensions
- ▶ Saves costs, as the prevailing periphery can be retained
- ▶ Suitable for cable lengths up to 3,000 metres

Keep up-to-date on safe line inspection devices PLIDdys:



Webcode 6892

Online information at www.pilz.com

| Dimensions (L x W x H) in mm | Features | Order numbers |
|-----------------------------------|--|--|
| 36 x 26 x 12.1 ¹⁾ | <ul style="list-style-type: none"> ▶ Cable cross section of 0.5 mm² to 1.5 mm² ▶ Maximum cable length 3000 m ▶ Cable resistance maximum 220 Ohm ▶ Supply voltage 24 VDC ▶ Weight 10 g ▶ Temperature range -30 °C ... +70 °C | <ul style="list-style-type: none"> ▶ PLID d1 _____ 774 260 ▶ PLID d1 C³⁾ _____ 784 260 |
| 101/94 ²⁾ x 22.5 x 121 | <ul style="list-style-type: none"> ▶ Outputs using semiconductor technology: <ul style="list-style-type: none"> - 2 safety outputs - 2 auxiliary outputs ▶ Outputs: Voltage/current/rating: <ul style="list-style-type: none"> ▶ 24 VDC/1.5 A/40 W ▶ Monitored or automatic reset can be selected ▶ Monitoring of shorts across contacts can be selected for E-STOP application | <ul style="list-style-type: none"> ▶ PNOZ e8.1p with spring-loaded terminals _____ 784 198 ▶ PNOZ e8.1p with plug-in screw terminals _____ 774 198 |

¹⁾ Height of version with spring-loaded terminal 12.5 mm

²⁾ Height with spring-loaded terminals/plug-in screw terminals

³⁾ Version with spring-loaded terminal



► Safety relays PNOZpower

The safety relays PNOZpower are suitable for monitoring emergency stop devices, safety gates and light beam devices. PNOZpower can switch currents of up to 16 A AC/DC per contact. An overall breaking capacity of 40 A is available per module.



PNOZ p1p

PNOZ po3p

Switching high loads safely

External contactors and contactor combinations are no longer required. The control circuit and main circuit are switched with one safety relay. The EC type examination is valid for the whole safety circuit.

Modular and flexible

The base module processes the inputs; the output modules are specifically matched to the respective load. The number and capacity of the required safety contacts can be scaled, depending on the application. A maximum of five modules can be connected to the base unit. Modules are wired to the base unit via an internal bus system.

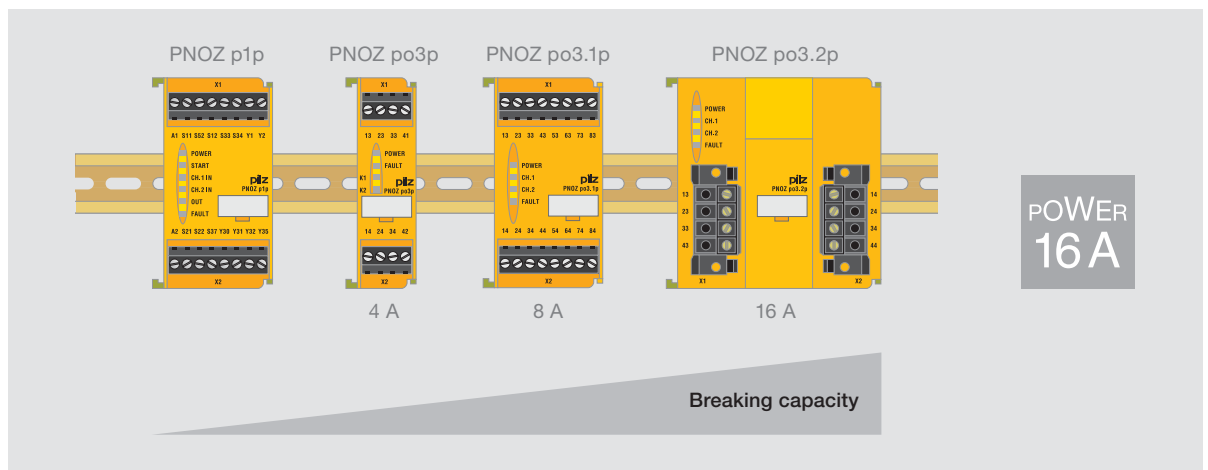

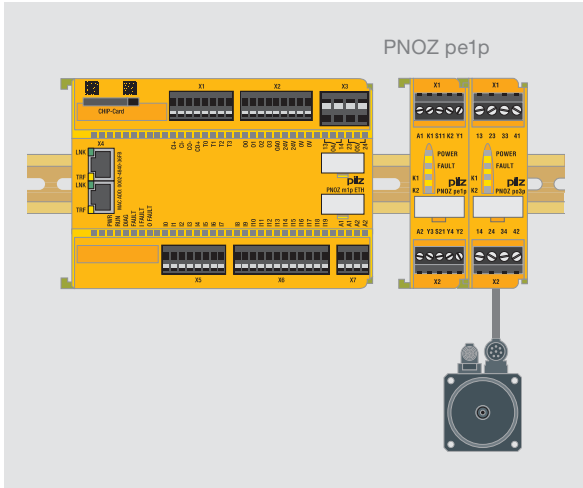

Volt-free switching with the control module PNOZ pe1p

In conjunction with at least one expansion module from the PNOZpower range, the control module PNOZ pe1p safely shuts down motors or supply voltages on valves and contactors.

The PNOZ pe1p can be driven via:

- ▶ The safety relays PNOZelog, PNOZ X and PNOZsigma
- ▶ The configurable control system PNOZmulti
- ▶ The programmable control systems PSS
- ▶ The safe bus system SafetyBUS p

Benefit to you: volt-free switching up to 16 A.

Your benefits at a glance

- ▶ External contactor combinations and their respective wiring are no longer required, saving costs, space and commissioning time
- ▶ Diagnostics via LED: operating and fault status can be scanned on each module, resulting in fewer downtimes
- ▶ Plug-in connection terminals: pre-wired and easy to exchange if there is a fault
- ▶ Redundant load switching
- ▶ Scalable and flexible by selecting compatible modules – you only pay for the functions that you actually use
- ▶ Complete solution comprising evaluation devices, compatible sensor technology and control and signal devices

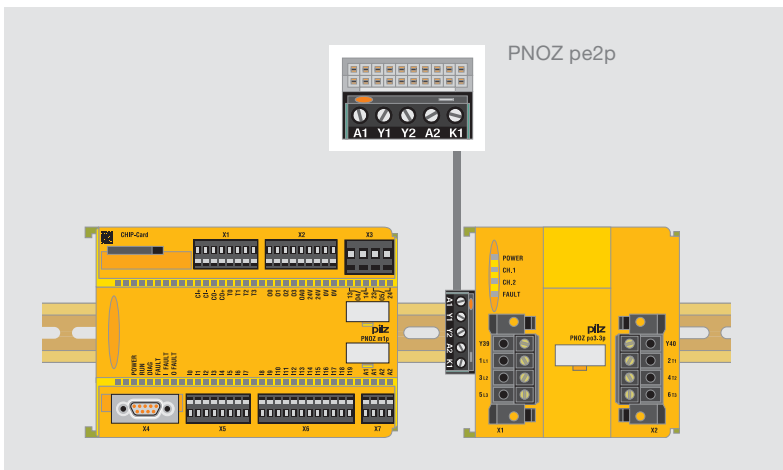

Safety relays PNOZpower and the configurable control system PNOZmulti are easily combined using the coupling connector PNOZ pe2p.

Connection to PNOZmulti

Specially developed for connection to the configurable control system PNOZmulti, PNOZpower units can be docked via the coupling connector PNOZ pe2p.





Keep up-to-date on safety relays PNOZpower:

Webcode 5238

Online information at www.pilz.com

► Selection guide – PNOZpower

Base units – Safety relays PNOZpower

| Type | Scope | Application | | | | Performance Level (PL) – EN ISO 13849-1 |
|-----------|--------------------|---|--|---|---|---|
| | |  |  |  |  | |
| PNOZ p1p | Base unit | ◆ | ◆ | ◆ | | e |
| PNOZ p1vp | Base unit, delayed | ◆ | ◆ | ◆ | ◆ | e (d) ¹⁾ |

Contact expansion modules – Safety relays PNOZpower

| Type | Output contacts | | Performance Level (PL) – EN ISO 13849-1 |
|-------------|---|---|---|
| | Safe  | Non-safe  | |
| PNOZ po3p | 3 | 1 | e |
| PNOZ po3.1p | 8 | - | e |
| PNOZ po3.2p | 4 | - | e |
| PNOZ po3.3p | 3 | - | e |
| PNOZ po4p | 4 | - | e |

Accessories – Safety relays PNOZpower

| Type | Scope | Application | Performance Level (PL) – EN ISO 13849-1 |
|------------|----------------|--|---|
| PNOZ pe1p | Control module | For control via safety contacts or safe semiconductor outputs | e |
| PNOZ pe2p | Bus interface | Coupling connector for connecting PNOZpower expansion modules to a higher-level control system | e |
| PNOZ pps1p | Power supply | - | - |

| Safety Integrity Level (SIL) CL – claim limit in accordance with IEC 62061 | Number of expansion modules | Supply voltage | Dimensions (H x W x D) in mm |
|--|---|----------------|------------------------------|
| 3 | Min. 1, max. 4 expansion modules | 24 VDC | 94 x 45 x 135 |
| 3 | Min. 1, max. 8 expansion modules (max. 4 delayed and 4 instantaneous) | 24 VDC | 94 x 45 x 135 |

¹⁾ Value applies for instantaneous (delayed) safety contacts

| Safety Integrity Level (SIL) CL – claim limit in accordance with IEC 62061 | Number of expansion modules | | | Dimensions (H x W x D) in mm |
|--|--|--|-----------------|------------------------------|
| | AC1 | AC3 | DC1 | |
| 3 | 240 V/4 A/960 VA | - | 24 V/4 A/96 W | 94 x 22.5 x 121 |
| 3 | 240 V/8 A/2 000 VA | - | 24 V/8 A/200 W | 94 x 45 x 121 |
| 3 | 240 V/16 A/4 000 VA | - | 24 V/16 A/400 W | 94 x 90 x 135 |
| 3 | 240 V/16 A/4 000 VA 400 V/10 A/4 000 VA 500 V/8 A/4 000 VA | 240 V/3.0 kW 400 V/5.5 kW 500 V/4.0 kW | 24 V/16 A/400 W | 94 x 90 x 135 |
| 3 | 240 V/4 A/960 VA | - | 24 V/4 A/96 W | 94 x 22.5 x 121 |

| Safety Integrity Level (SIL) CL – claim limit in accordance with IEC 62061 | Number of expansion modules | Supply voltage | Dimensions (H x W x D) in mm |
|--|----------------------------------|-----------------|------------------------------|
| 3 | Min. 1, max. 4 expansion modules | 24 VDC | 94 x 22.5 x 121 |
| 3 | Min. 1, max. 6 expansion modules | 24 VDC | 29 x 23.5 x 22 |
| - | - | 100 ... 240 VAC | 94 x 45 x 121 |

Technical documentation on safety relays PNOZelog:

 Webcode 0685

Online information at www.pilz.com

► Technical details – PNOZpower

Safety relays PNOZpower



PNOZ p1p



PNOZ pe1p



PNOZ pe2p



PNOZ pps1p



PNOZ po3p



PNOZ po3.2p

| Type | Scope | Inputs/outputs | Supply voltage |
|------------------------|--------------------|---|--------------------|
| ★ PNOZ p1p | Base unit | 2 semiconductor outputs | 24 VDC |
| PNOZ p1vp | Base unit, delayed | 2 semiconductor outputs | 24 VDC |
| PNOZ pe1p | Control module | Expansion module control output connected to the PNOZpower bus | 24 VDC |
| PNOZ pe2p | Bus interface | Output connected to PNOZpower bus | 24 VDC |
| PNOZ pps1p | Power supply | - | 100 ... 240 VAC/DC |
| ★ PNOZ po3p, PNOZ po4p | Expansion modules | <ul style="list-style-type: none"> ► PNOZ po3p: <ul style="list-style-type: none"> - 3 safety contacts (N/O) - 1 auxiliary contact (N/C) ► PNOZ po4p: <ul style="list-style-type: none"> - 4 safety contacts (N/O) | Via PNOZpower bus |
| PNOZ po3.1p | Expansion module | 8 safety contacts (N/O) | Via PNOZpower bus |
| PNOZ po3.2p | Expansion module | 4 safety contacts (N/O) | Via PNOZpower bus |
| ★ PNOZ po3.3p | Expansion module | 3 safety contacts (N/O) | Via PNOZpower bus |

| Features | Order numbers | |
|--|--|--|
| | Plug-in screw terminals | |
| <ul style="list-style-type: none"> ▶ Dual-channel wiring, with or without detection of shorts across contacts ▶ Monitored or automatic reset can be selected ▶ Connection between PNOZ p1p and expansion modules via PNOZpower bus, using jumpers on the back of the unit | 773300 | |
| <ul style="list-style-type: none"> ▶ Dual-channel wiring, with or without detection of shorts across contacts ▶ Monitored or automatic reset can be selected ▶ Delay time can be selected via rotary switch and potentiometer ▶ Connection between PNOZ p1vp and expansion modules via PNOZpower bus, using jumpers on the back of the unit | <ul style="list-style-type: none"> ▶ 30 s _____ 773950 ▶ 300 s _____ 773951 | |
| <ul style="list-style-type: none"> ▶ 1-channel operation, without detection of shorts across contacts ▶ 2-channel operation, with or without detection of shorts across contacts ▶ Connection between the PNOZ pe1p and expansion modules via the PNOZpower bus, employing jumpers on the rear face of the unit. ▶ Status indicator for output relay, supply voltage and fault ▶ Connection for feedback loop | 773900 | |
| <ul style="list-style-type: none"> ▶ Driven via safety contacts or safe semiconductor outputs ▶ 1-channel operation, without detection of shorts across contacts ▶ Connection between PNOZ pe2p and expansion modules via the PNOZpower bus | 779125 | |
| <ul style="list-style-type: none"> ▶ Galvanic isolation ▶ Short circuit-proof ▶ 24 VDC at the plug-in connector on the back of the unit for the PNOZpower bus and at the terminals ▶ LEDs for supply voltage, output voltage and fault | 773200 | |
| <ul style="list-style-type: none"> ▶ 2-channel operation with the ability to detect short circuits via the base unit ▶ LEDs for switch status of channels 1/2, supply voltage and fault | <ul style="list-style-type: none"> ▶ PNOZ po3p _____ 773634 ▶ PNOZ po4p _____ 773635 | |
| | 773630 | |
| | 773631 | |
| <ul style="list-style-type: none"> ▶ 2-channel operation with the ability to detect short circuits via the base unit ▶ LEDs for switch status of channels 1/2, supply voltage and fault ▶ Suitable for safety-related switching of loads with utilisation category AC3 (e.g. motor) ▶ External start/stop input for non-safety-related load switching | 773632 | |



★ Type recommended by Pilz

Technical documentation on safety relays PNOZpower:

Webcode 0685

Online information at www.pilz.com

► Software tool PNOZmulti Configurator – All for

10
YEARS
INNOVATION
PNOZmulti



PNOZmulti Configurator

Ingeniously simple, simply ingenious

Do you know about the original software tool PNOZmulti Configurator, which is both ingeniously simple and simply ingenious? If not, then it's time you did. You can use it to plan, configure, document and commission the safety circuit quite simply on the PC with a software tool. The PNOZmulti Configurator configures all PNOZmulti product ranges:

- Configurable safety relays PNOZmulti Mini
- Configurable control system PNOZmulti
- Configurable control system PNOZmulti 2



Simply order the demo CD-ROM – you'll be amazed.















Flexible to use and child's play to operate

The safety circuit elements are available on the graphics-based, Windows®-compliant user interface as icons or in selection menus.

First select the necessary hardware via drag & drop. The hardware consists of a base unit and, if necessary, expansion modules. The number of available inputs and outputs is displayed in a table. The software tool provides support, for example, by listing the expansion modules available for the selected base unit. The tool can also help if the permitted number of expansion modules has been exceeded or if modules have been positioned incorrectly. Online help with documentation is always available during configuration.

The completed safety circuit is transferred from the PNOZmulti Configurator to a PNOZmulti base unit on a chip card.

Function elements

-  E-STOP
-  Safety gate
-  Light curtain
-  Two-hand pushbutton
-  Enabling switch
-  Operating mode selector switch
-  User-defined element
-  Pressure sensitive mat
-  Safety gate with interlock
-  Foot switch
-  Pushbutton
-  Key switch
-  Limit switch
-  Analogue

one, one for all

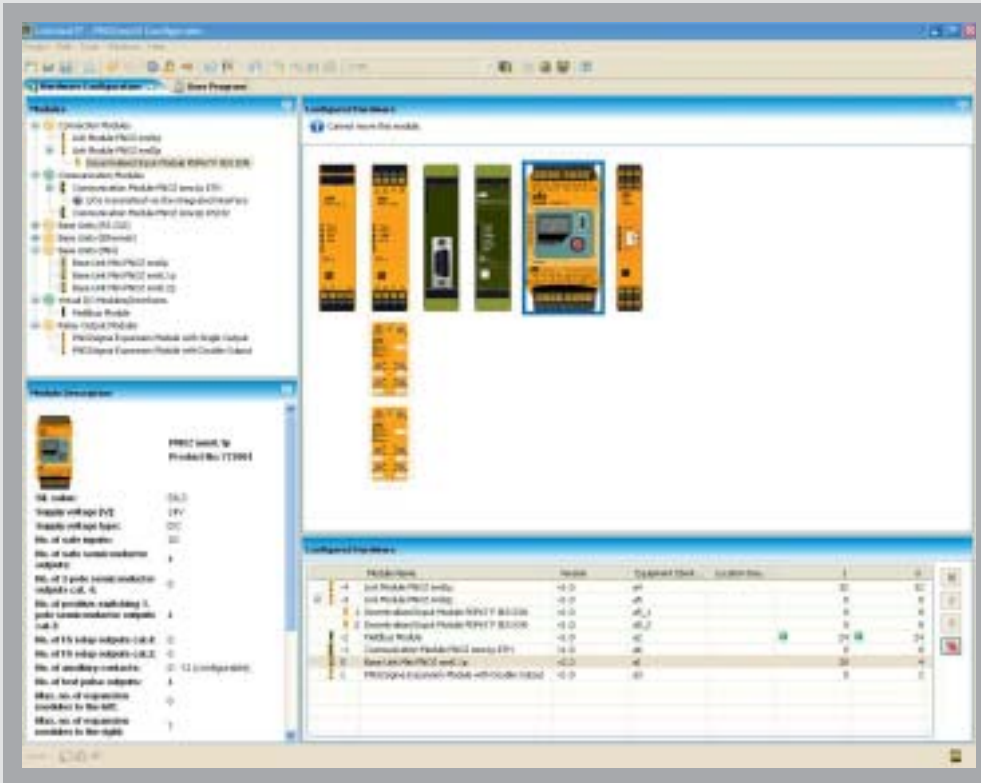

Logic elements

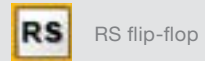
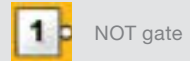
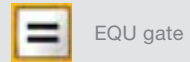
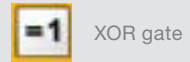
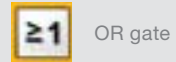
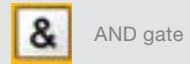

Output elements

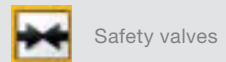
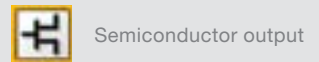
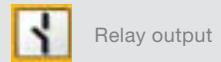

Diagnostic elements

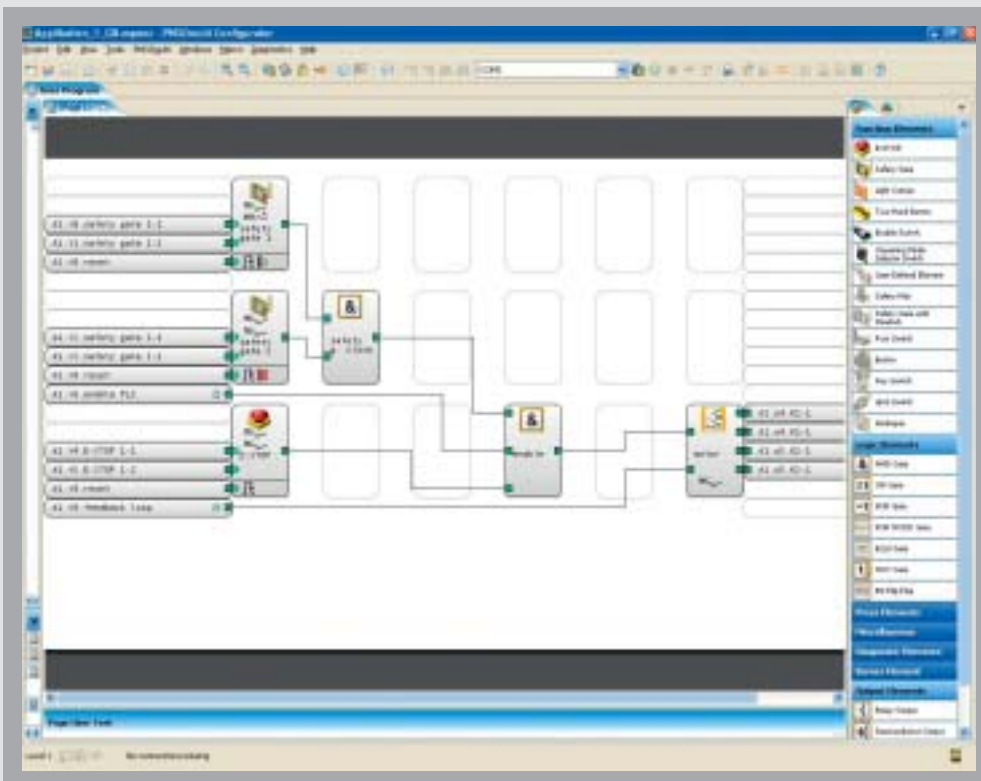
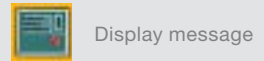
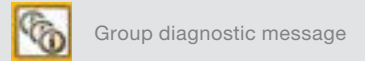
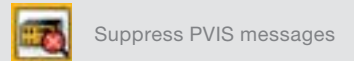
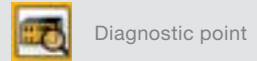
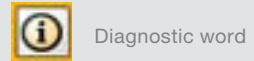

► Diagnostics made simple

Diagnostic concept PVIS – with one-click selection

Thanks to the modern diagnostic concept PVIS, with PNOZmulti and PMI operator terminals you have an overall, integrated diagnostic solution, which reduces downtimes significantly. If a fault occurs, features such as plain text messages with precise information on the location, clearly defined responsibilities and integrated first fault display all ensure that production is quickly restarted. You can customise these messages or use the existing pre-defined messages.

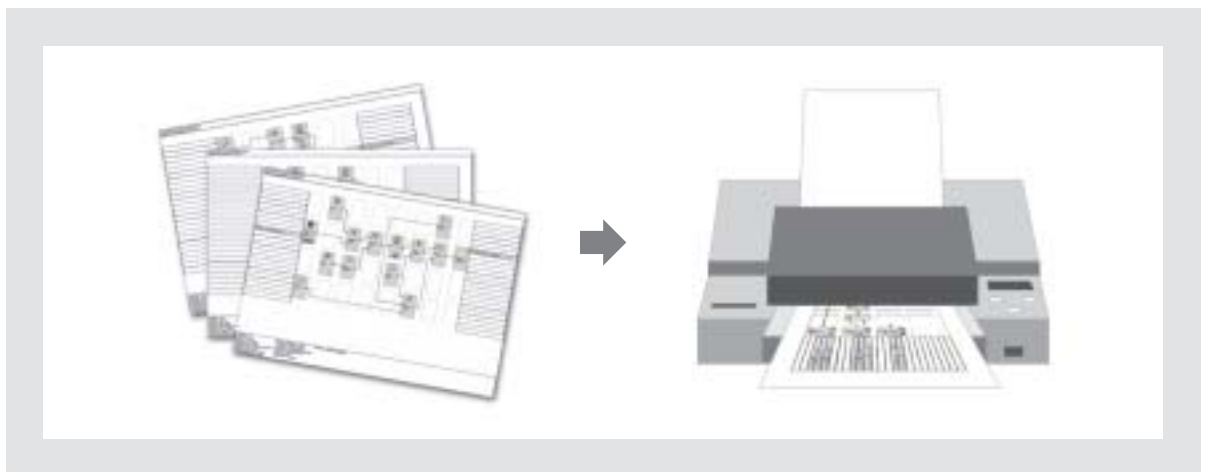

Doubly safe

Once the configuration is complete, the configuration tool checks the circuit for any errors. The completed configuration can be locked using three levels of password protection. It can also be certified to protect it from unwanted modifications. If the configuration has not been certified, it can be edited, modified and extended at any time by calling it up in the Configurator. The configuration can be printed out and used as documentation.

Maintenance is simple with the PNOZmulti service licence

The PNOZmulti service tool is specifically used for troubleshooting and diagnostics during service and maintenance, directly on the machine for example. The current status of the configuration is visible during operation (powerflow). Any options that can be used to modify a project are disabled.

► Enter a new dimension with macro elements

The logic connections that are defined between inputs and outputs can be combined into macro elements. Once created, macro elements are stored in the macro library. They are then available for use in all further configurations. A simple import and export function and the ability to edit macros within the editor reduce your engineering time and save costs. Macros can also be read and write protected, so protecting your expertise.

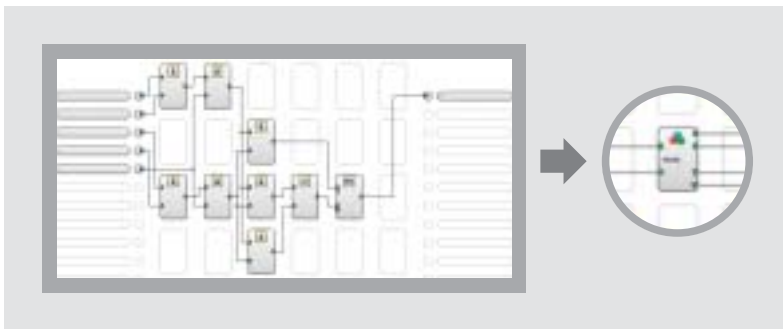

A wide range of logic connections can be combined to form a macro.

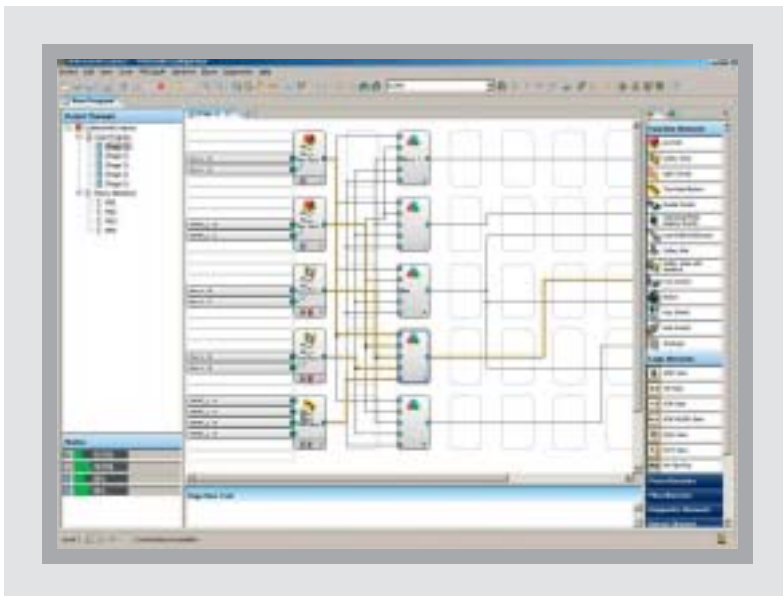

More logic connections are available to you with macros.

Your benefits at a glance

- Create just once, re-use again and again: you save time on subsequent projects, while quality always stays the same. Any changes to a macro element in the project are adapted automatically in this configuration.
- You can implement larger, more complex projects: macro elements put the max. permitted number of 253 connection lines into perspective
- Save time during diagnostics and when troubleshooting
 - Your projects become clearer
 - Macro elements are displayed in powerflow
 - Diagnostic information can be mapped
- Support is quickly available: you only send the macro elements and not the entire project
- New functionalities can be implemented without changing the hardware. Thanks to the "Sensor/block evaluation device" bundle you can use certified Pilz macro elements.

Keep up-to-date on the software tool PNOZmulti Configurator:



Webcode 8633

Online information at www.pilz.com

► Technical details – PNOZmulti Configurator

Software tool – PNOZmulti Configurator



| Type | Features |
|------------------------|---|
| PNOZmulti Configurator | <ul style="list-style-type: none"> ▶ Graphic tool for configuration and programming of the configurable control system PNOZmulti ▶ Project configuration, configuration generation, documentation, commissioning ▶ Data transfer via serial interface or chip card ▶ User interface in German, English, French, Italian, Spanish, Japanese, Chinese (selectable) ▶ System requirements (from Version 8.0.0): <ul style="list-style-type: none"> - Operating system: Windows® XP/Server 2003/Vista - Standard PC with min. 1 GHz processor - RAM: min. 1 024 MByte - Hard disk: 20 GByte, min. 15 GByte of available disk space - Supports Super VGA graphics - DVD drive ▶ In order to use the full scope of the PNOZmulti Configurator, you will need a valid licence in addition to the software package. Without a licence, the PNOZmulti Configurator can only be used in a demo version. A range of licences are available to meet varying requirements. ▶ Licence types are available as a full version or service version. <ul style="list-style-type: none"> - Full version: The full version provides the whole functional range of a licence. - Service version: The service version of a licence is intended for service and maintenance. The service version only offers limited editing features. |

PNOZmulti Tool Kit



| Type | Features |
|--------------------|---|
| PNOZmulti Tool Kit | <ul style="list-style-type: none"> ▶ The Tool Kit comes in a carry case and contains the accessories you need to start working with PNOZmulti: <ul style="list-style-type: none"> - Documentation folder with the PNOZmulti Configurator Software and Manual - Chip card reader to write and save the configuration on to a chip card - Chip card set consisting of 10 chip cards, including a chip card adapter for rewriting chips removed from the chip card - Configuration cable for reading diagnostic data (5 m) - Mounting bracket |



| Licence type | Order numbers | | |
|---|--|--------------|-----------------|
| | Type | Full version | Service version |
| <p>▶ Basic licence: Single user licence, issued to one owner (company name and location/project must be stated)</p> <p>▶ User licence: Discounted licence for an additional workstation, issued to the owner of a basic licence</p> <p>▶ Lite licence: Licence limited to the base units PNOZ m0p and the base units PNOZmulti Mini, for use on one workstation.</p> <p>▶ Multi user licence: Multi user licence, graduated according to the number of workstations (up to 25, 50, 100 and over 100)</p> <p>▶ Project licence: Licence to use the software within a contractually limited framework</p> <p>▶ Basic/User/Multi user/Project upgrade licence: Discounted licence enabling owners of a licence to change to a newer version of the software</p> <p>▶ Time limited licence: Basic licence restricted to 2, 3 or 4 months</p> | <p>▶ DVD and documentation folder ¹⁾ ___ 773 000D</p> <p>▶ DVD ¹⁾ _____ 773 000D</p> <p>▶ Basic Licence 773010B</p> <p>▶ User Licence 773010K</p> <p>▶ Lite Licence 773010L</p> <p>▶ Multi User Licence 773010M</p> <p>▶ Project Licence 773010G</p> <p>▶ Time Limited Licence, 2 months 773010S</p> <p>▶ Time Limited Licence, 3 months 773010R</p> <p>▶ Time Limited Licence, 4 months 773010Q</p> <p>Upgrade</p> <p>▶ Basic Upgrade Licence 773010U</p> <p>▶ User Upgrade Licence 773010V</p> <p>▶ Multi User Upgrade Licence 773010N</p> <p>▶ Project Upgrade Licence 773010W</p> | | |

¹⁾ Please order licence separately; this is required in order to activate the software; other licence types available on request

| Order numbers | | | | | |
|--------------------|----------------------|---|----------------------|--|----------------------------|
| PNOZmulti Tool Kit | Chip card reader | Chip cards | Configuration cable | Documentation folder with PNOZmulti Configurator | Licence type |
| 779000 | 779230 ²⁾ | <p>▶ 8 kByte (1 piece) ___ 779201²⁾</p> <p>▶ 8 kByte (10 pieces) ___ 779200²⁾</p> <p>▶ 32 kByte (1 piece) ___ 779211²⁾</p> <p>▶ 32 kByte (10 pieces) ___ 779212²⁾</p> | 310300 ²⁾ | 773000 | 773010... |
| | | | | Please order licence separately | see PNOZmulti Configurator |

Keep up-to-date on the software tool PNOZmulti Configurator:

Webcode 8633

Online information at www.pilz.com

²⁾ For use only with subsequent orders

► Configurable safety relays PNOZmulti Mini

Do you need to monitor more than three safety functions, comfortably with as few clicks as possible in one software tool? Then the configurable safety relays PNOZmulti Mini are the right solution for you. Play it safe and use PNOZmulti Mini – the worldwide safety standard for all machine types. Irrespective of the standard control system, you will always have a one-stop safety solution, which can easily be adapted to changing requirements.

10
YEARS
INNOVATION
PNOZmulti



PNOZ mm0.1p

As simple as a safety relay, as flexible as a controller

In 2009, Pilz developed the first configurable safety relay PNOZmulti Mini in a compact, stand-alone version PNOZ mm0p. With a width of just 45 mm, it provides concentrated functionality. A modular, expandable base unit was launched in 2010. In conjunction with the configurable control systems PNOZmulti we can offer a universal, scalable product range, providing both stand-alone and system solutions. All safety functions are easy to create using the software tool PNOZmulti Configurator.

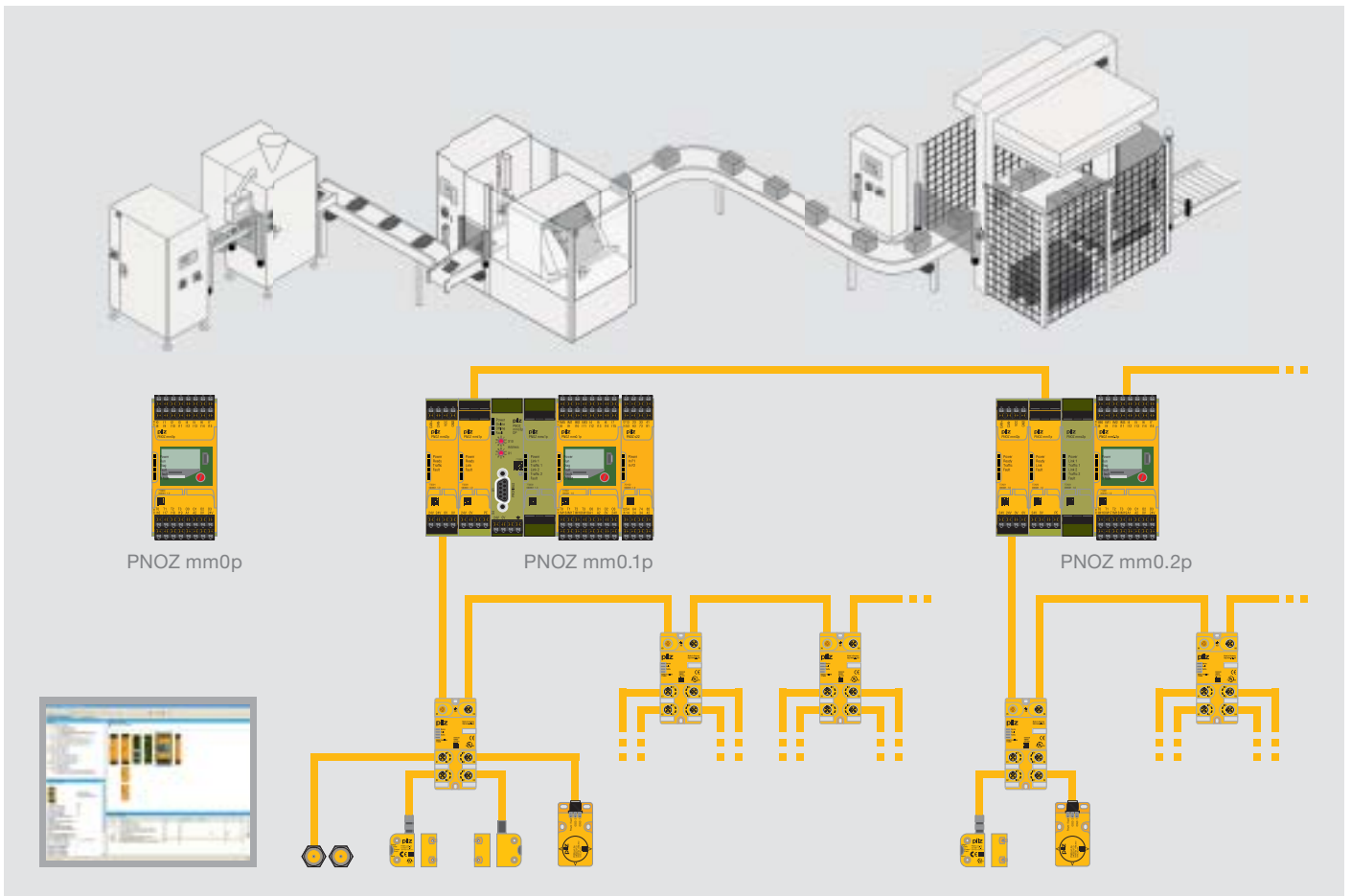

Compact device – Base unit PNOZ mm0p

At a width of just 45 mm, the stand-alone base unit has 20 freely configurable safe inputs, 4 safe semiconductor outputs (PL e/SIL CL 3) and 4 test pulse outputs. The compact design saves space in the control cabinet. The integrated display offers simple diagnostics and the ability to display customised texts. Short commissioning times and simple wiring save costs.

Genial device – Base unit PNOZ mm0.1p is modular and expandable

The base unit PNOZ mm0.1p is ready to meet growing requirements. It has the same technical features as the PNOZ mm0p. The big difference: it is modular and expandable. By selecting the appropriate modules and performing a simple configuration, you can expand your application easily and economically. Expand to the left using safe link modules, communication modules and fieldbus modules. Contact expansion modules from the PNOZsigma product range are available to multiply the relay contacts on the right-hand side.

Communicative device – Base unit PNOZ mm0.2p Multi-Link inside

In addition to the functionality of the PNOZ mm0.1p, the base unit PNOZ mm0.2p also provides an integrated multi-link interface. This removes the need for an additional module, saving you costs. As a result, it is easy to link and exchange data between several base units PNOZmulti Mini and between PNOZmulti Mini and PNOZmulti.

Your benefits at a glance

- ▶ Efficient from three safety functions onwards
- ▶ Save time and costs in all engineering phases through the software tool PNOZmulti Configurator
- ▶ Maximum flexibility: inputs and outputs are freely configurable
- ▶ Saves a lot of space in the control cabinet due to its compact design
- ▶ Reduced downtimes thanks to PVIS support
- ▶ Customer texts can be displayed
- ▶ Worldwide safety standard for all machine types



Simply order the demo CD-ROM – you'll be amazed.



Keep up-to-date on the configurable safety relays PNOZmulti Mini:



Webcode 5245

Online information at www.pilz.com

► Configurable safety relays PNOZmulti Mini

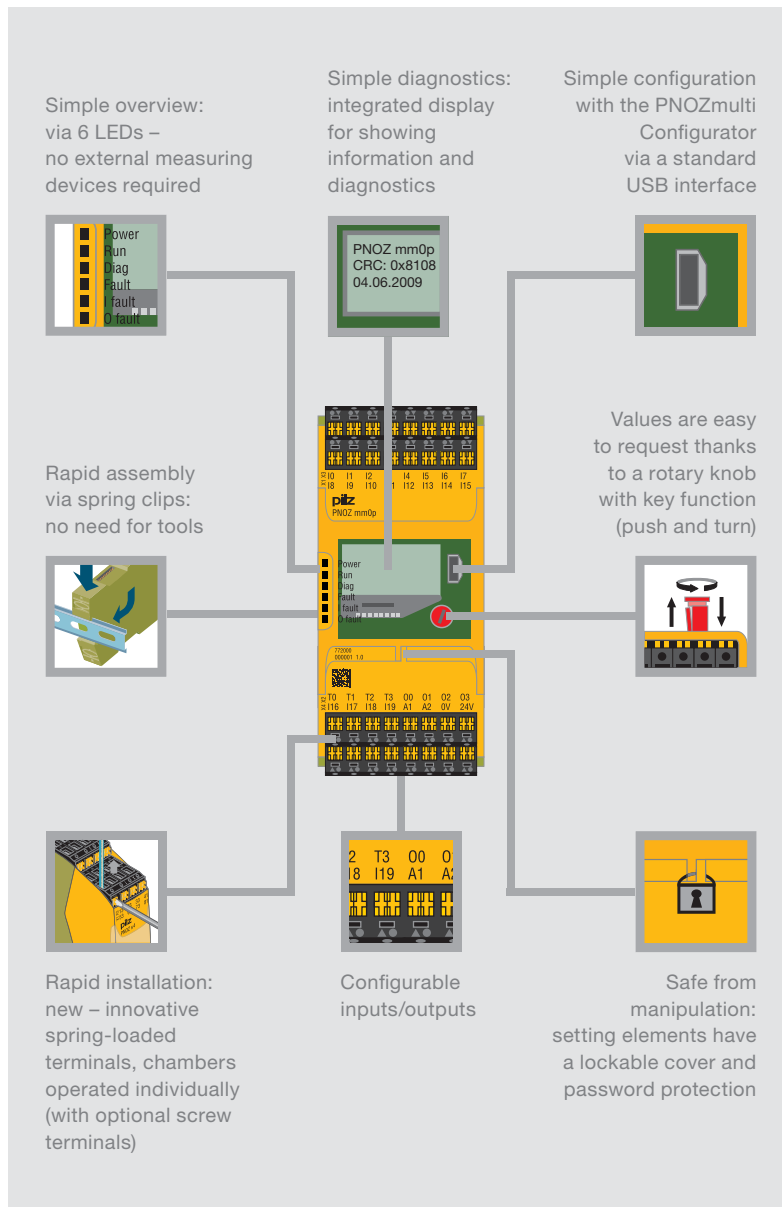

PNOZ mml1p



PNOZ mml2p

PNOZ mml1p – Safely linked for larger applications

The safe link module PNOZ mml1p (Multi-Link) is used to connect multiple base units. It enables data to be exchanged simply between multiple PNOZmulti Mini base units as well as between PNOZmulti Mini and PNOZmulti.

PNOZ mml2p – Decentralised in the field with safe sensor technology

Decentralised periphery is connected via the link module PNOZ mml2p. The IP67 input modules PDP67 can be used to connect your sensor technology outside the control cabinet, directly in the field. As a result, interlinked and decentralised systems can also be implemented using PNOZmulti Mini.

► User-friendly diagnostics

User-friendly diagnostic information with fieldbus modules

Using fieldbus modules, base units can be expanded on the left-hand side and can be connected to the fieldbus systems PROFIBUS-DP, DeviceNet and CANopen. Another new feature is the ability to use either the communication module PNOZ mmc1p ETH or PNOZ mmc2p serially in conjunction with a fieldbus module. You can configure the fieldbus inputs and outputs along with the fieldbus modules in the software tool PNOZmulti Configurator. The fieldbus modules are used to read the diagnostic data and to set virtual inputs/outputs for standard functions.

Your benefits at a glance

- User-friendly diagnostic and control information guarantees short downtimes and high plant availability
- Two-way signalling and control via fieldbus modules
- Diagnostic concept PVIS can be activated via a single click in the PNOZmulti Configurator, individual customer texts are child's play to integrate
- Connect the operator terminals PMI for an overall, integrated diagnostic solution

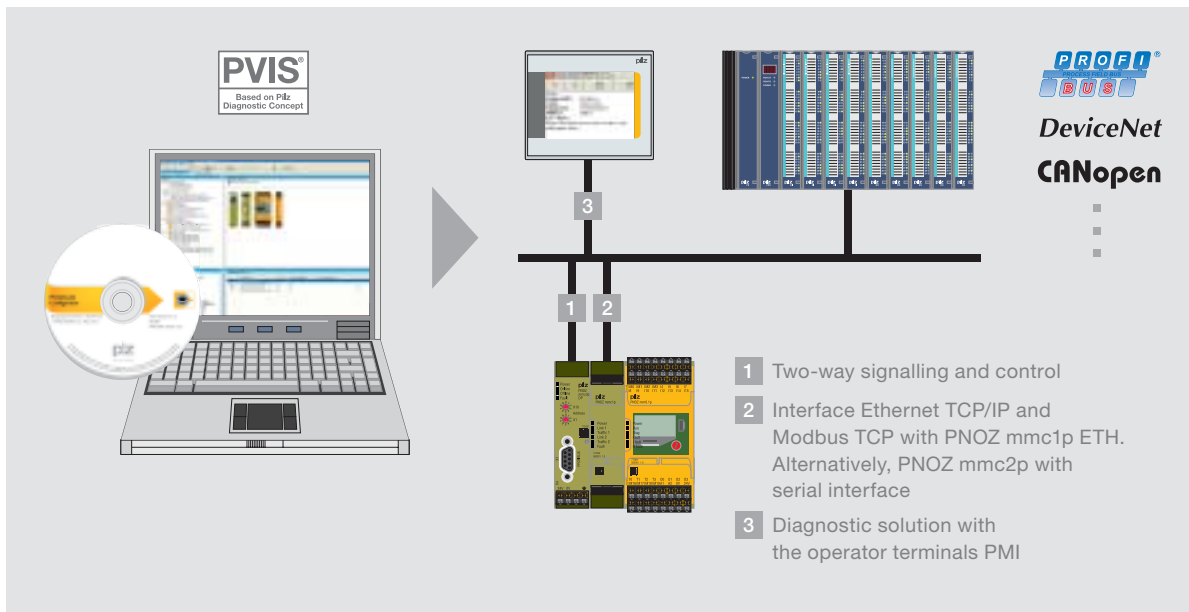

► Selection guide – PNOZmulti Mini



Configurable safety relays PNOZmulti Mini

| Type | Application area | Performance Level (PL) – EN ISO 13849-1 ¹⁾ |
|---|---|---|
| PNOZ mmc1p ETH | Communication module Ethernet TCP/IP and Modbus TCP | - |
| PNOZ mmc2p serial | Communication module, serial interface | - |
| PNOZ mmc3p DP | Fieldbus module PROFIBUS-DP | - |
| PNOZ mmc4p DN | Fieldbus module DeviceNet | - |
| PNOZ mmc6p CAN | Fieldbus module CANopen | - |
| PNOZ mml1p Multi-Link | Safe link module Multi-Link | e |
| PNOZ mml2p PDP67 | Safe link module PDP67 | e |
| PNOZ s7 PNOZ s7.1/s7.2 PNOZ s10 PNOZ s11 PNOZ s22 | Output modules (contact expansion) from the product range PNOZsigma (see page 28) | e |

| Safety Integrity Level (SIL) CL – Claim limit in accordance with IEC 62061 | Connection of expansion modules to base unit | | |
|--|--|---------------------------|-----------------------------------|
| | PNOZ mm0p ²⁾ | PNOZ mm0.1p ²⁾ | PNOZ mm0.2p ²⁾ |
| | 3 ... 6 safety functions (non-expandable) | ≥ 4 safety functions | ≥ 4 safety functions + Multi-Link |
| - | | ◆ | ◆ |
| - | | ◆ | ◆ |
| - | | ◆ | ◆ |
| - | | ◆ | ◆ |
| - | | ◆ | ◆ |
| 3 | | ◆ | ◆ |
| 3 | | ◆ | ◆ |
| 3 | | ◆ | ◆ |



¹⁾ Maximum achievable value, depending on the application, e.g. number of outputs

²⁾ All base units comply with PL e and SIL CL 3

Technical documentation on configurable safety relays PNOZmulti Mini:

Webcode 0685

Online information at www.pilz.com

► Technical details – PNOZmulti Mini



Configurable safety relays PNOZmulti Mini

Common features of the base units

PNOZ mm0p/mm0.1p/mm0.2p:

- ▶ Configurable using PNOZmulti Configurator via chip card or USB interface
- ▶ Exchangeable program memory
- ▶ 20 inputs, up to 8 of which can be configured as auxiliary outputs
- ▶ 4 safe semiconductor outputs (PL e, SIL CL 3)
- ▶ 4 test pulse outputs, up to 4 of which can be configured as standard outputs
- ▶ Supply voltage (U_B): 24 VDC
- ▶ Voltage/current/rating: 24 VDC/2 A/48 W, outputs using semiconductor technology
- ▶ With display for error messages, state of the supply voltage, state of the inputs and outputs, status and device information. Customised texts can be displayed
- ▶ Rotary knob for menu control
- ▶ Dimensions (H x W x D): 100/98¹⁾ x 45 x 120 mm



PNOZ mm0p



PNOZ mm0.1p



PNOZ mm0.2p



PNOZ mmc1p ETH



PNOZ mmc2p seriell

| Type | Scope |
|--------------------|--|
| PNOZ mm0p | Base unit – Non-modular and expandable, from 3 ... 6 safety functions |
| PNOZ mm0.1p | Base unit – Modular and expandable, from 4 safety functions and for standard control functions |
| PNOZ mm0.2p | Base unit – As PNOZ mm0.1p, with an additional integrated multi-link interface |
| PNOZ mmc1p ETH | Communication module, subscriber on Ethernet TCP/IP and Modbus TCP |
| PNOZ mmc2p seriell | Communication module with serial interface RS232 |

| Features | Order numbers | | |
|--|--|----------------------------|----------------------------|
| | Excl. terminals | Push-in spring terminals | Plug-in screw terminals |
| <p>Application area: to connect emergency stop devices, two-hand buttons, safety gate limit switches, light beam devices, scanners, enabling switches, safety gate switches PSEN, operating mode selector switches, muting, pressure sensitive mats, sensors</p> | <p>772 000</p> <p>Mini USB cable</p> <ul style="list-style-type: none"> ▶ 3 m _____ 312 992 ▶ 5 m _____ 312 993 <p>▶ Chip card 8 kByte, 1 piece _____ 779 201</p> <p>▶ Chip card 32 kByte, 1 piece _____ 779 211</p> | <p>751 008 (1 set)</p> | <p>750 008 (1 set)</p> |
| <ul style="list-style-type: none"> ▶ As PNOZ mm0p ▶ Expandable to the left using the link modules PNOZ mml1p Multi-Link, PNOZ mml2p PDP and a communication module PNOZ mmc1p ETH or PNOZ mmc2p serial. A fieldbus module may also be connected ▶ Expandable to the right using a contact expansion module PNOZsigma: PNOZ s22 or s7, s7.1, s7.2, s10, s11 ▶ Decentralisation: sensor technology can be connected via the PDP67 F 8DI ION ▶ PVIS support | <p>772 001</p> | <p>751 008 (1 set)</p> | <p>750 008 (1 set)</p> |
| | <ul style="list-style-type: none"> ▶ Can be configured using the PNOZmulti Configurator ▶ Subscriber (Slave) on Ethernet ▶ 2 Ethernet interfaces ▶ Transmission rate 10 Mbit/s ▶ Status indicators via LEDs ▶ Max. 1 communication module can be connected to the left of the base unit; a fieldbus module can also be connected ▶ Connected to base unit via a link on the back of the unit ▶ Dimensions (H x W x D): 100 x 22.5 x 120 mm | <p>772 002</p> | <p>751 008 (1 set)</p> |
| <ul style="list-style-type: none"> ▶ Can be configured using the PNOZmulti Configurator ▶ Subscriber (Slave) on Ethernet ▶ 2 Ethernet interfaces ▶ Transmission rate 10 Mbit/s ▶ Status indicators via LEDs ▶ Max. 1 communication module can be connected to the left of the base unit; a fieldbus module can also be connected ▶ Connected to base unit via a link on the back of the unit ▶ Dimensions (H x W x D): 100 x 22.5 x 120 mm | <p>772 030</p> | <p>-</p> | <p>-</p> |
| <ul style="list-style-type: none"> ▶ Can be configured using the PNOZmulti Configurator ▶ 1 serial interface RS232 ▶ Status indicators via LEDs ▶ Max. 1 communication module can be connected to the left of the base unit; a fieldbus module can also be connected ▶ Connected to base unit via a link on the back of the unit ▶ Dimensions (H x W x D): 100 x 22.5 x 120 mm | <p>772 031</p> | <p>783 538 (1 set)</p> | <p>793 538 (1 set)</p> |



Technical documentation on configurable safety relays PNOZmulti Mini:

Webcode 0685

Online information at www.pilz.com

¹⁾ Height with spring-loaded terminals/plug-in screw terminals

► Technical details – PNOZmulti Mini



Configurable safety relays PNOZmulti Mini



PNOZ mmc3p DP



PNOZ mmc4p DN



PNOZ mmc6p CAN



PNOZ mml1p



PNOZ mml2p

| Type | Scope |
|---------------------------------------|--|
| PNOZ mmc3p DP | Fieldbus module PROFIBUS-DP |
| PNOZ mmc4p DN | Fieldbus module DeviceNet |
| PNOZ mmc6p CAN | Fieldbus module CANopen |
| PNOZ mml1p Multi-Link | Safe link module Multi-Link |
| PNOZ mml2p PDP | Safe link module PDP67 to connect a base unit to up to 4 decentralised modules PDP67 |
| PDP67 F 8DI ION PDP67 F 8DI ION HP | Decentralised input modules |

| Features | Order numbers | | |
|---|-----------------|-------------------------|-------------------------|
| | Excl. terminals | Spring-loaded terminals | Plug-in screw terminals |
| <ul style="list-style-type: none"> ▶ Can be configured using the PNOZmulti Configurator ▶ Subscriber (Slave DPV0) on PROFIBUS-DP ▶ Station addresses from 0 ... 99, selected via rotary switch ▶ Transmission rate: max. 12 Mbit/s ▶ Connection to fieldbus: via 9-pin female D-Sub connector ▶ Dimensions (H x W x D) in mm: 100 x 22.5 x 115 | 772 032 | 783 542 (1 set) | 793 542 (1 set) |
| <ul style="list-style-type: none"> ▶ Subscriber (Slave) on DeviceNet ▶ Station addresses from 0 ... 63, selected via DIP switch ▶ Transmission rate: 500 kbit/s ▶ Connection to fieldbus: via 5-pin Combicon plug-in connector ▶ Dimensions (H x W x D) in mm: 100 x 22.5 x 110 | 772 033 | 783 542 (1 set) | 793 542 (1 set) |
| <ul style="list-style-type: none"> ▶ Subscriber (Slave) on CANopen ▶ Station addresses from 0 ... 99, selected via rotary switch ▶ Transmission rate: max. 1 Mbit/s ▶ Transmission rate selected via rotary switch ▶ Connection to fieldbus: via female 9-pin D-Sub connector ▶ Dimensions (H x W x D) in mm: 100 x 22.5 x 115 | 772 034 | 783 542 (1 set) | 793 542 (1 set) |
| <ul style="list-style-type: none"> ▶ Link module to safely connect base units PNOZmulti Mini and PNOZmulti Mini or PNOZmulti Mini and PNOZmulti ▶ Point-to-point connection via 4-core shielded, twisted-pair cable ▶ 32 virtual inputs and 32 virtual outputs ▶ Max. four PNOZ mml1p units can be connected to the base unit ▶ Dimensions (H x W x D) in mm: 100 x 22.5 x 120 | 772 020 | 783 538 (1 set) | 793 538 (1 set) |
| <ul style="list-style-type: none"> ▶ Ability to connect up to four expansion modules to the base unit PNOZ mm0.1p or mm0.2p ▶ Max. four decentralised input modules PDP67 can be connected to an expansion module (16 sensors with a maximum configuration) ▶ Dimensions (H x W x D) in mm: 98/100¹⁾ x 22.5 x 120 | 772 021 | 783 540 (1 set) | 793 540 (1 set) |
| <ul style="list-style-type: none"> ▶ For information please refer to pages 96 and 97 | - | - | - |



¹⁾ Height with spring-loaded terminals/plug-in screw terminals

Technical documentation on configurable safety relays PNOZmulti Mini:

Webcode 0685

Online information at www.pilz.com

► Configurable control system PNOZmulti

The configurable control system PNOZmulti is ideal when several safety functions are to be implemented on a machine. Instead of wiring, you can simply configure your safety circuit on a PC. PNOZmulti is multifunctional, freely configurable and tailor-made for use in many areas of mechanical engineering.

10
YEARS
INNOVATION
PNOZmulti



PNOZ m1p ETH

The PNOZmulti monitors safety functions such as E-STOP, safety gates, light beam devices, two-hand and many more. All safety functions are created with the software tool PNOZmulti Configurator. The hardware configuration with the selection of base unit and expansion modules can also be made easily via the PNOZmulti Configurator. So you can reduce your engineering times and get to market quicker. You can then save the completed configuration on to a chip card. From there it is transferred to the base unit.

In using the PNOZmulti you're backing the original – the continual expansion of the product range safeguards your investment.

Even subsequent changes can be made quickly via the software tool. Modular and expandable, with the ability for expansion via link modules, the PNOZmulti can grow with the requirements or size of a machine.



Simply order the demo CD-ROM – you'll be amazed.

The right module for every requirement ...

If your plant expands, the PNOZmulti simply expands with it. Expansion modules are available to extend the modular system; these can be used in any combination to suit the requirement:

- Input and output modules, e.g. the safe analogue input module
- Fieldbus modules
- Safe speed and standstill monitors
- Safe link modules for the safe interconnection of several PNOZmulti base units or the safe interconnection of decentralised periphery

... even for special applications

- Base unit PNOZ m2p for press applications
- Base unit PNOZ m3p for burner management

Keep up-to-date on configurable control systems PNOZmulti:

Webcode 5245

Online information at www.pilz.com



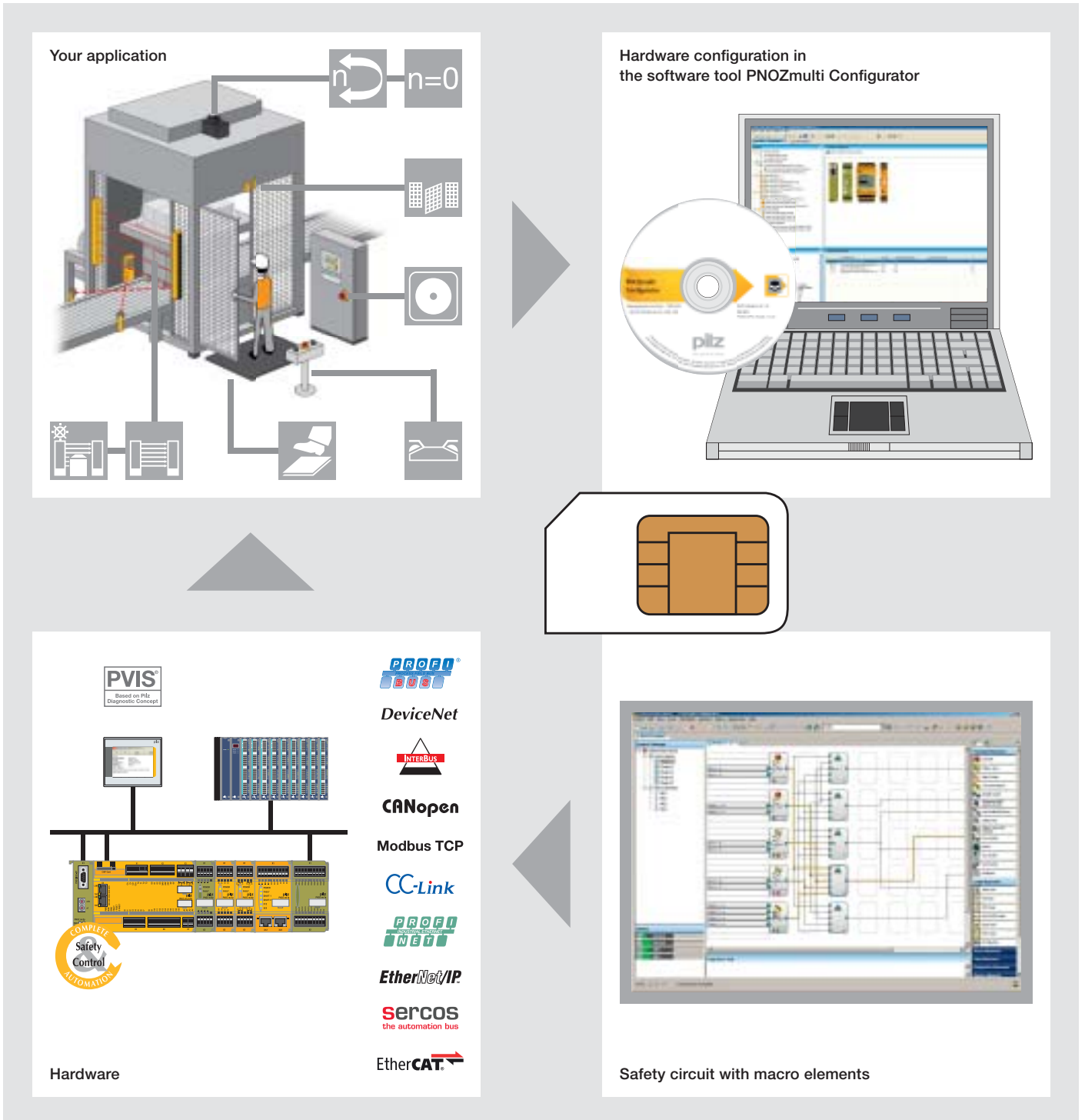

Example: using the PNOZmulti configurable control system on a packaging machine.

► Modular and flexible

Safe and economical in all industries

PNOZmulti is used in numerous applications across the widest range of industries. Intelligent merging of safety-related and standard control functions, the modular concept and simple configuration mean the system can control from the simplest machine to distributed plants. PNOZmulti is so flexible that it can also be adapted to suit your application – guaranteed.

Application areas may include:

- General mechanical engineering,
e.g. lathes, milling and drilling machines
- Plastics processing machines,
e.g. blow moulding machines
- Laser machines,
e.g. laser welding and laser punching machines
- Packaging machines,
e.g. drink dispensing and palletising machines
- Forming technology,
e.g. hydraulic presses, eccentric presses,
press brakes, small presses and punch presses
- Robot cells,
e.g. processing, welding and spraying robots
- Print and paper industry,
e.g. printing, enveloping and paper machines
- Other applications, e.g. on wind turbines, in the air industry, in pleasure parks, in cable car technology, in the automotive industry, in the pharmaceutical industry and in many other sectors

Today, the PNOZmulti is the most widely used safety system in the world. We can also monitor your plant or machinery, whatever the application – just ask. Your safety is our standard.



Your benefits at a glance

- ▶ One system to cover safety-related and standard control functions
- ▶ Ideal for covering applications of four safety functions and above
- ▶ Up to 40% potential savings in all engineering phases thanks to a graphics configuration tool
- ▶ Chip card for data transfer; easy copy function is of particular interest to series users
- ▶ No need to draw complex circuit diagrams: simply print out the completed configuration
- ▶ Simple wiring means short commissioning times
- ▶ Subsequent modifications and adjustments to the configuration are simple to make
- ▶ Simple and economical to expand by selecting compatible modules
- ▶ Simple, user-friendly diagnostics mean short downtimes and high plant availability
- ▶ Saves a lot of space in the control cabinet
- ▶ Certified worldwide
- ▶ Possible to have a complete solution comprising evaluation devices, compatible sensor technology and control and signal devices

From planning to maintenance

Bring your machinery to market more quickly. Compared with conventionally wired solutions you can save up to 40% of your time and costs – in all engineering phases – during design, configuration, commissioning, operation and maintenance.

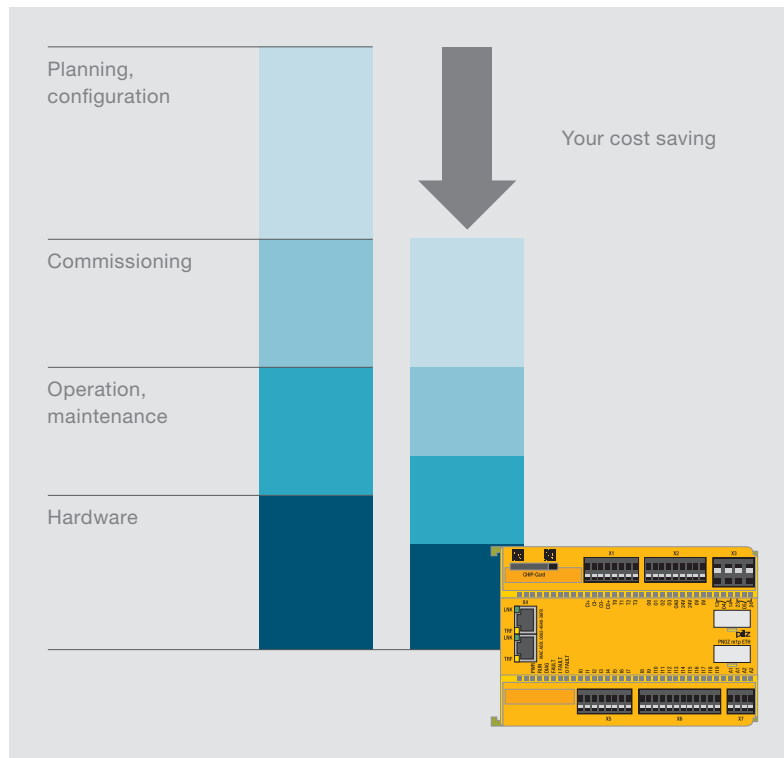

► The basis for each application: many functions –

All PNOZmulti base units have 20 inputs, 4 safe semiconductor outputs and 2 relay outputs.
Versions are available with serial or ETH interface.

Base unit PNOZ m0p – The compact solution ...

... reduces your costs even further thanks to simple diagnostics, for example via fieldbus modules for all common fieldbus systems. Particularly suitable for use on small machines, the PNOZ m0p manages without any expansion modules.

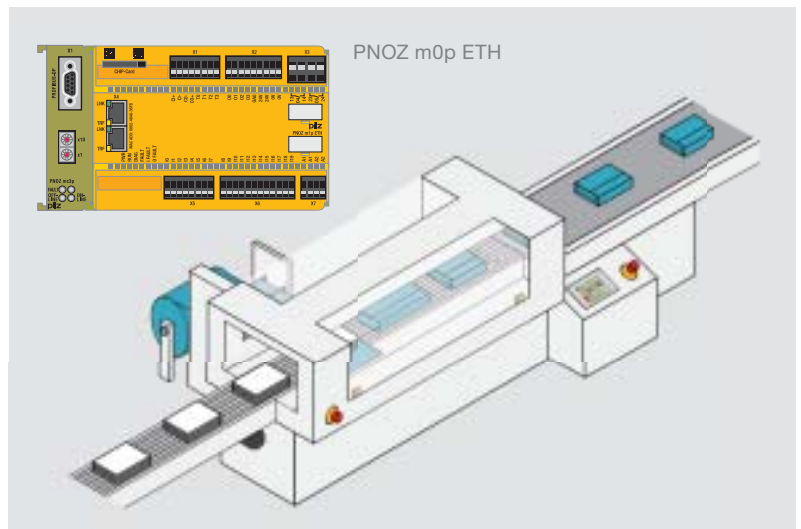

Ideal for three to six safety functions!

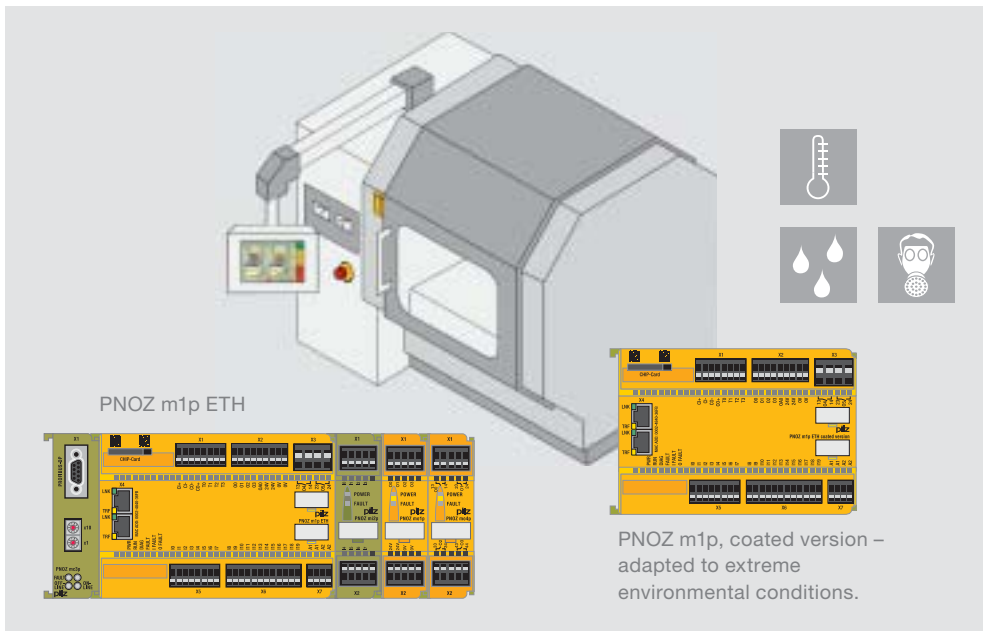

PNOZ m1p, coated version – adapted to extreme environmental conditions.

PNOZ m1p – The all-rounder ...

... is ideal for small to medium-sized machines. Standard control functions can also be monitored alongside the safety functions. The PNOZ m1p is expandable and, depending on the type and number of expansion modules, there are almost no limits for the application of the PNOZmulti.

PNOZ m1p for an extended temperature range ...

... tough and specially designed for use in a rugged everyday industrial environment, the PNOZ m1p coated version is particularly well protected from environmental influences. The benefits include an extended temperature range, tolerance of condensation and resistance to corrosive gas. We can also supply numerous expansion modules for an extended temperature range. These are identified with the description “coated version”.

one solution!

PNOZ m2p – Withstands plenty ...

... and is specially designed to control and monitor small and average-sized eccentric and hydraulic presses. Approved software blocks are available for operating modes such as set-up mode, single-stroke and automatic, and to monitor safety light curtains in single-break or double-break mode; these blocks make the system simple and economical to use.

In conjunction with the dual-pole semiconductor output module PNOZ mo3p, the PNOZ m2p can control press safety valves safely and economically.

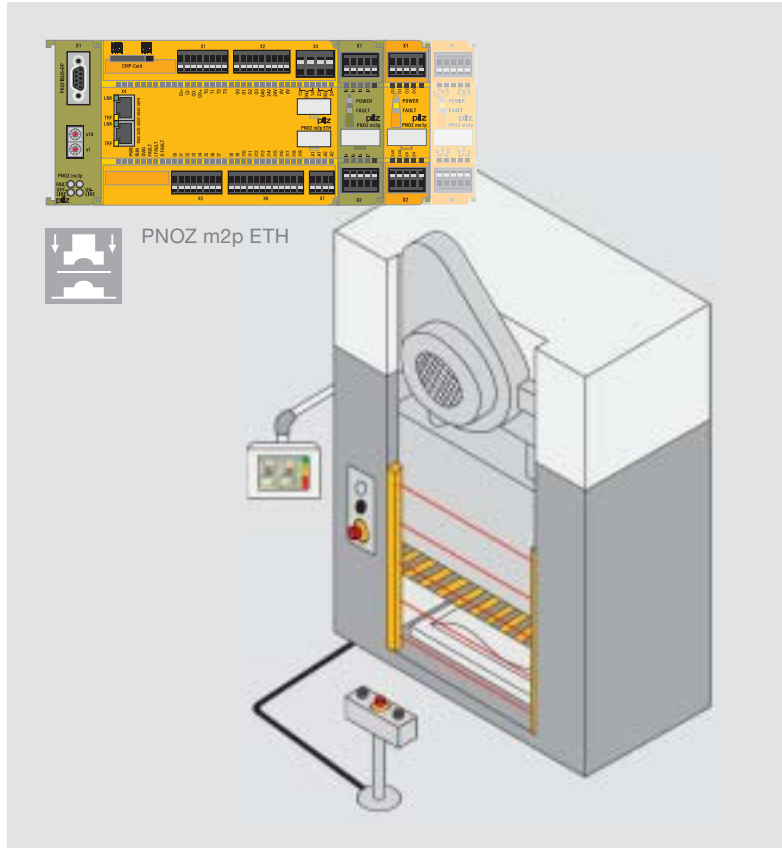

Specifically for press applications

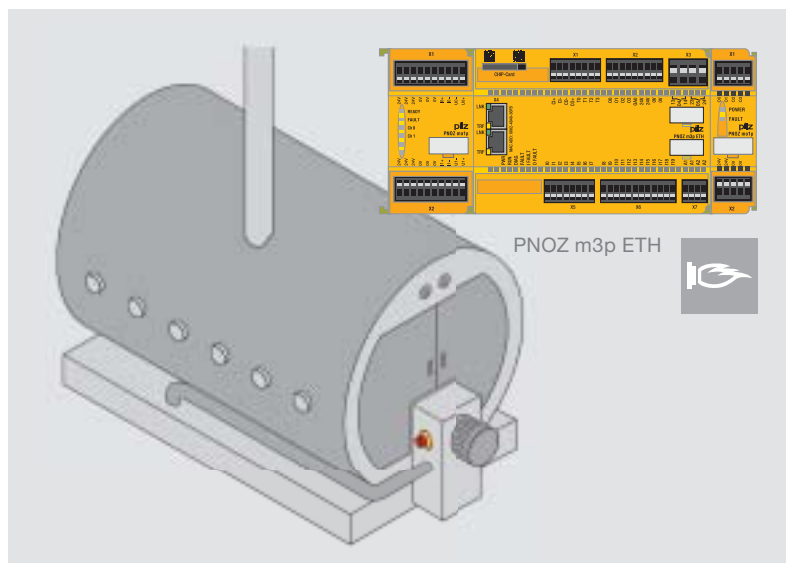

Specifically for burner management

PNOZ m3p – controls and monitors furnaces ...

... monitors safety chains, for example. The safe ignition of the fuel and the monitoring of a furnace during operation are safety-related criteria that prevent an explosion with serious damages. With the configurable control system PNOZ m3p you have a safety-related solution to hand that fulfils these requirements.

Keep up-to-date on the configurable control system PNOZmulti:

 Webcode 5548

Online information at www.pilz.com

► For increased cost-effectiveness



PNOZ ma1p

Monitoring analogue input signals safely

The safe analogue input module PNOZ ma1p provides two independent, safe inputs. Up to eight limit values can be defined for each input with just a few clicks of the mouse in the PNOZmulti Configurator. The inputs are suitable for connecting transducers or encoders with standardised 10 V voltage signals or 20 mA current signals. As users you benefit from rapid commissioning and reduced wiring. With its analogue input module, the PNOZmulti is particularly suitable for the process engineering sector, as well as for cable car and chair lift design and burner controls.

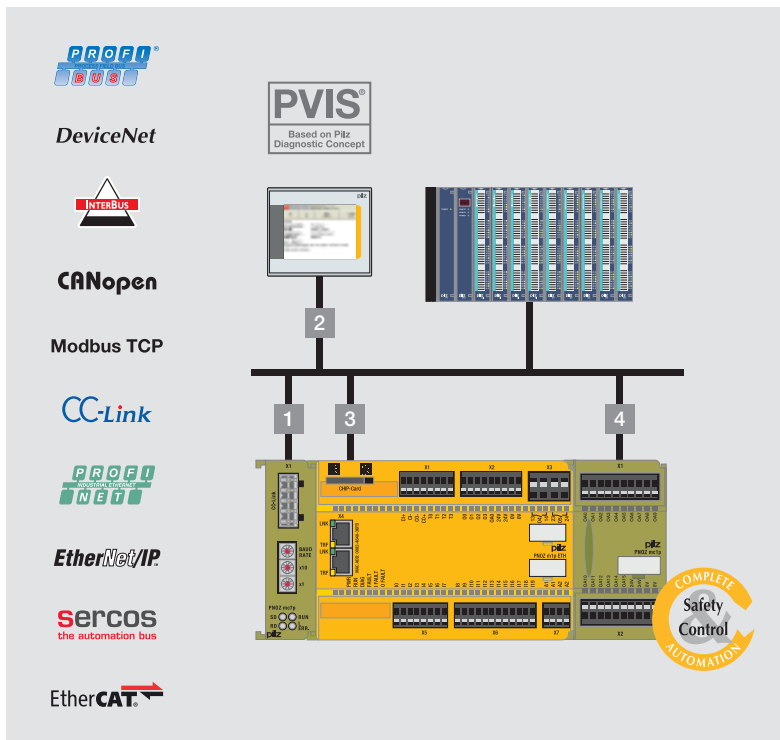

Diagnostics with PNOZmulti – Always in the picture

User-friendly diagnostic and control information guarantees short downtimes and high plant availability. With PNOZmulti there are several options for diagnostics:

- 1 Two-way signalling and control: can be connected to all common fieldbus systems
- 2 Diagnostic solution with the operator terminals PMI
- 3 Interface Ethernet TCP/IP and Modbus TCP
- 4 Status messages to the PLC: PNOZ mc1p



Scan the QR code to find out more about the diagnostic concept PVIS.



Reduce downtimes with PVIS

Thanks to the modern PVIS diagnostic concept, PNOZmulti and PMI operator terminals can provide an overall, integrated diagnostic solution. If a fault occurs, features such as plain text messages with precise information on the location, clearly defined responsibilities and integrated first fault display all ensure that production is quickly restarted. The PNOZmulti Configurator contains the PNOZmulti project, texts for diagnostics, proposed solutions and more. The benefits are obvious: there's less configuration, greater flexibility and downtimes are reduced.

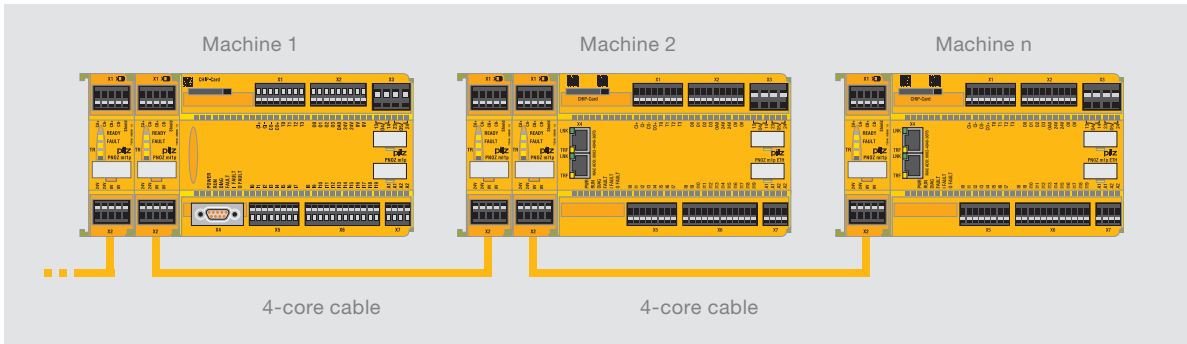

PNOZ ml1p – for the safe connection of PNOZmulti base units.

Even complex tasks can be mastered within a network

The safe link module PNOZ ml1p enables data to be exchanged simply between several PNOZmulti base units. The benefit: if a unit’s physical limits are exhausted, users can employ several PNOZmulti devices, enabling them to monitor and control more complex machinery. Selective shutdown and commissioning of plant sections are also a possibility.

The modular structure of the PNOZmulti enables you to connect up to four PNOZ ml1p link modules to each base unit, allowing both ring and tree structures to be established. You can quickly and easily allocate the information to be transferred within the PNOZmulti Configurator. No specialist knowledge of safe bus systems is required, nor do the connected devices need to be specifically addressed.

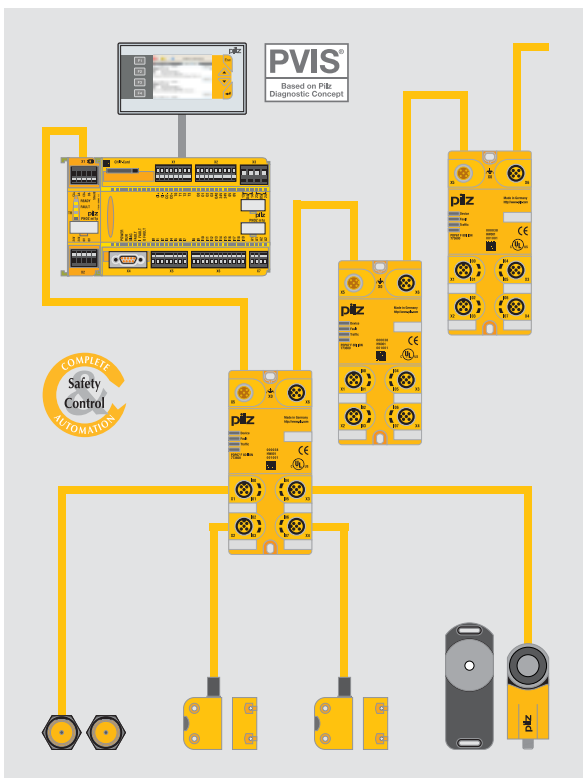

Decentralised in the field with safe sensor technology

The safe link module PNOZ ml2p is used to safely transfer the input information from decentralised modules to the control system PNOZmulti. Sensor technology can be connected outside the control cabinet via the IP67 input module PDP67 F 8DI ION. You have less planning and design work thanks to the software tool PNOZmulti Configurator. So not only can you monitor all safety functions safely but also directly in the field. As a result, interlinked and decentralised plants can also be implemented with PNOZmulti.

Further information on:

▶ Input/output modules:

👉 Webcode 5548

▶ Communication modules

👉 Webcode 5548

Online information at www.pilz.com

► Selection guide – PNOZmulti



Configurable control system PNOZmulti

| Type | Scope | Performance Level (PL) – EN ISO 13849-1 ¹⁾ | Safety Integrity Level (SIL) CL – Claim limit in accordance with IEC 62061 ¹⁾ |
|---|---|---|--|
| PNOZ mi1p | Safe input module | e | 3 |
| PNOZ mi2p | Input module | e | 3 |
| PNOZ ma1p | Safe analogue input module | e | 3 |
| PNOZ mo1p | Safe semiconductor output modules | e | 3 |
| PNOZ mo3p | 2-pole, safe semiconductor output module | e | 3 |
| PNOZ mo2p, PNOZ mo4p | Safe relay output modules | e | 3 |
| PNOZ mo5p | Safe relay output module, diverse | e | 3 |
| PNOZ mc1p | Output module | - | - |
| PNOZ ms1p, PNOZ ms2p, PNOZ ms2p HTL, PNOZ ms2p TTL, PNOZ ms3p, PNOZ ms3p HTL, PNOZ ms3p TTL, PNOZ ms4p | Safe speed and standstill monitoring modules | e | 3 |
| PNOZ ml1p | Safe link module Multi-Link | e | 3 |
| PNOZ ml2p | Safe link module PDP | e | 3 |
| PNOZ mc2p, PNOZ mc2.1p | Fieldbus modules EtherCAT | - | - |
| PNOZ mc3p | Fieldbus module PROFIBUS-DP | - | - |
| PNOZ mc4p | Fieldbus module DeviceNet | - | - |
| PNOZ mc5p | Fieldbus module Interbus | - | - |
| PNOZ mc5.1p | Fieldbus module Interbus FO | - | - |
| PNOZ mc0p Powersupply | Power supply for Interbus fieldbus modules PNOZ mc5p/PNOZ mc5.1p | - | - |
| PNOZ mc6p, PNOZ mc6.1p | Fieldbus modules CANopen | - | - |
| PNOZ mc7p | Fieldbus module CC-Link | - | - |
| PNOZ mc8p | Fieldbus module Ethernet/IP/Modbus | - | - |
| PNOZ mc9p | Fieldbus module PROFINET | - | - |
| PNOZ mc10p | Fieldbus module Sercos III | - | - |

► Technical details – PNOZmulti



Base units – PNOZmulti control systems



PNOZ m1p

| Type | Scope |
|---|--|
| PNOZ m0p, PNOZ m0p ETH | Base unit – From 3 ... 6 safety functions Only link modules and fieldbus modules can be connected, no other expansion modules can be used |
| ★ PNOZ m1p, PNOZ m1p ETH, PNOZ m1p coated version, PNOZ m1p ETH coated version | Base unit – from 4 safety functions and for standard control functions |
| PNOZ m2p, PNOZ m2p ETH | Base unit – Specifically for press applications: Monitoring of operating modes such as setup, single-stroke and automatic, safety light curtains in single-break and double-break mode, camshaft with run monitoring, press safety valves |
| PNOZ m3p, PNOZ m3p ETH | Base unit – Specifically for burner management: Control and monitoring of furnaces, e.g. monitoring of safety sequences, combustion air pressure, ignition, flame, external compound controller and tightness control; plus control of safety valves, ignition valves, exhaust valves, ignition, external compound controller and combustion air blower |

Input modules – PNOZmulti I/O



PNOZ mi1p

| Type | Scope | Inputs/outputs |
|--|-------------------|---------------------------------|
| PNOZ mi1p, PNOZ mi1p coated version | Safe input module | 8 safe inputs |
| PNOZ mi2p | Input module | 8 inputs for standard functions |

| Features | Order numbers | | | |
|--|---|-------------------------|-------------------------|--|
| | Excl. terminals | Spring-loaded terminals | Plug-in screw terminals | |
| <ul style="list-style-type: none"> ▶ Application area: to connect emergency stop devices, two-hand buttons, safety gate limit switches, light beam devices, scanners, enabling switches, safety gate switches PSEN, operating mode selector switches, muting, pressure sensitive mats, sensors ▶ Configurable using PNOZmulti Configurator via chip card or RS 232 interface/Ethernet interface ▶ Exchangeable program memory ▶ Diagnostic interface ▶ Max. 1 fieldbus module can be connected ▶ PNOZ m1p/PNOZ m2p/PNOZ m3p: Max. 8 expansion modules can be connected ▶ Inputs/outputs: <ul style="list-style-type: none"> - 20 freely configurable inputs, 4 test pulse outputs, 1 auxiliary output - Outputs using semiconductor technology: 4 safety outputs - Relay outputs: 2 safety contacts ▶ Supply voltage (U_g): 24 VDC ▶ Voltage/current/rating: <ul style="list-style-type: none"> - Outputs using semiconductor technology: 24 VDC/2 A/48 W - Relay outputs: DC1: 24 V/6 A/144 W ▶ Dimensions (H x W x D): 94 x 135 x 121 mm | <ul style="list-style-type: none"> ▶ PNOZ m0p _____ 773 110 ▶ PNOZ m0p ETH _____ 773 113 ▶ Chip card 8 kByte, 1 piece _____ 779 201 ▶ Chip card 32 kByte, 1 piece _____ 779 211 | 783 100 | 793 100 | |
| | <ul style="list-style-type: none"> ▶ PNOZ m1p _____ 773 100 ▶ PNOZ m1p ETH _____ 773 103 ▶ PNOZ m1p coated version _____ 773 105 ▶ PNOZ m1p ETH coated version _____ 773 104 | 783 100 | 793 100 | |
| | <ul style="list-style-type: none"> ▶ PNOZ m2p _____ 773 120 ▶ PNOZ m2p ETH _____ 773 123 | 783 100 | 793 100 | |
| | <ul style="list-style-type: none"> ▶ PNOZ m3p _____ 773 125 ▶ PNOZ m3p ETH _____ 773 126 | 783 100 | 793 100 | |
| | | | | |
| | | | | |



★ Type recommended by Pilz

| Features | Order numbers | | |
|---|---|-------------------------|-------------------------|
| | Excl. terminals | Spring-loaded terminals | Plug-in screw terminals |
| <ul style="list-style-type: none"> ▶ Max. 8 input modules can be connected to the base unit ▶ Connected to base unit via a link on the back of the unit | <ul style="list-style-type: none"> ▶ PNOZ mi1p _____ 773 400 ▶ PNOZ mi1p coated version _____ 773 405 | 783 400 (1 set) | 793 400 (1 set) |
| | 773 410 | 783 400 (1 set) | 793 400 (1 set) |

Technical documentation on the configurable control system PNOZmulti:

Webcode 0685

Online information at www.pilz.com

► Technical details – PNOZmulti



Input modules – PNOZmulti I/O



PNOZ ma1p

| Type | Scope | Inputs/outputs |
|---|----------------------------|---|
| PNOZ ma1p, PNOZ ma1p coated version | Safe analogue input module | 2 safe, analogue inputs for voltage or current measurement (configurable) |

Output modules – PNOZmulti I/O



PNOZ mo1p



PNOZ mc1p

| Type | Scope | Inputs/outputs |
|---|--|---|
| PNOZ mo1p, PNOZ mo1p coated version | Safe semiconductor output module: switching 24 V actuators | Outputs using semiconductor technology: 4 safety outputs |
| PNOZ mo2p, PNOZ mo2p coated version | Safe relay output module: volt-free switching of actuators | Relay outputs: 2 safety outputs |
| PNOZ mo3p | Safe semiconductor output module, 2-pole | 2-pole outputs using semiconductor technology: 2 safety outputs |
| PNOZ mo4p, PNOZ mo4p coated version | Safe relay output module: volt-free switching of actuators | Relay outputs: 4 safety outputs |
| PNOZ mo5p | Safe relay output module: to control the safety valves on a burner in accordance with EN 50156 | Positive-guided relay outputs, diverse: 4 safety outputs |
| PNOZ mc1p, PNOZ mc1p coated version | Output module: Status message to PLC | 16 auxiliary outputs using semiconductor technology |

Common features

- Connected to base unit via a link on the back of the unit
- Dimensions (H x W x D) in mm: 94 x 22.5 x 121, PNOZ mc1p: 94 x 45 x 121

| Features | Order numbers | | |
|--|---|-------------------------|-------------------------|
| | Excl. terminals | Spring-loaded terminals | Plug-in screw terminals |
| <ul style="list-style-type: none"> ▶ Range monitoring (4 range limits can be configured) ▶ Threshold value monitoring (8 limit values can be configured) ▶ Voltage range: -10.24 ... +10.2375 V ▶ Current range: 0 ... 25.59 mA ▶ Installed to the left of the base unit ▶ Max. 4 PNOZ ma1p units can be connected to the base unit ▶ Status indicators ▶ Dimensions (H x W x D): 94 x 45 x 121 mm | <ul style="list-style-type: none"> ▶ PNOZ ma1p ____ 773 812 ▶ PNOZ ma1p coated version ____ 773 813 | 783 700 (1 set) | 793 700 (1 set) |



| Outputs: Voltage/current/rating | Features | Order numbers | | |
|---------------------------------|--|---|-------------------------|-------------------------|
| | | Excl. terminals | Spring-loaded terminals | Plug-in screw terminals |
| 24 VDC/2 A/48 W | ▶ Max. 6 output modules can be connected to the right of the base unit | ▶ PNOZ mo1p ____ 773 500 | 783 400 (1 set) | 793 400 (1 set) |
| DC1: 24 V/6 A | | ▶ PNOZ mo1p coated version ____ 773 505 | | |
| 24 VDC/2 A | | ▶ 773 510 | 783 400 (1 set) | 793 400 (1 set) |
| DC1: 24 V/6 A | | ▶ PNOZ mo4p ____ 773 536 | 783 536 (1 set) | 793 536 (1 set) |
| DC1: 24 V/6 A/144 W | | ▶ PNOZ mo4p coated version ____ 773 537 | | |
| - | ▶ Max. 8 output modules can be connected to the right of the base unit | ▶ PNOZ mc1p ____ 773 700 | 783 700 (1 set) | 793 700 (1 set) |
| | | ▶ PNOZ mc1p coated version ____ 773 705 | | |

Technical documentation on the configurable control system PNOZmulti:

Webcode 0685

Online information at www.pilz.com

► Technical details – PNOZmulti



Safe speed and standstill monitors – PNOZmulti I/O modules

Common features

- ▶ Scope: The expansion modules monitor drives for standstill, speed and direction of rotation in set-up and automatic mode in accordance with EN ISO 13849-1 up to PL e and EN IEC 62061 up to SIL CL 3
- ▶ Incremental encoders are connected via connection cable
- ▶ Max. 4 speed monitors can be connected to the base unit
- ▶ Measured variables: standstill, speed, direction of rotation
- ▶ Axis types and reset mode can be selected in the PNOZmulti Configurator
- ▶ Dimensions (H x W x D) in mm: 94 x 45 x 121



PNOZ ms1p



PNOZ ms4p

| Type | Connectable encoders |
|---|--|
| PNOZ ms1p | Proximity switch, incremental encoder Sin/Cos, TTL (5 V) |
| PNOZ ms2p | Proximity switch, incremental encoder Sin/Cos, TTL (5 V), HTL (24 V) |
| PNOZ ms2p HTL | Proximity switch, incremental encoder HTL |
| PNOZ ms2p TTL, PNOZ ms2p TTL coated version | Proximity switch, incremental encoder Sin/Cos, TTL (5 V) |
| ★ PNOZ ms3p | Incremental encoder Sin/Cos, TTL (5 V), HTL (24 V) |
| PNOZ ms3p HTL | Incremental encoder HTL (24 V) |
| PNOZ ms3p TTL | Incremental encoder Sin/Cos, TTL (5 V) |
| PNOZ ms4p | Incremental encoder Sin/Cos, TTL (5 V), HTL (24 V) |

Link modules – PNOZmulti I/O modules

Common features

- ▶ Can be configured in the PNOZmulti Configurator
- ▶ Dimensions (H x W x D) in mm: 94 x 22.5 x 121



PNOZ ml1p

| Type | Scope |
|-------------------------------------|---|
| PNOZ ml1p, PNOZ ml1p coated version | To safely connect two PNOZmulti base units; tree or ring structure possible |
| ★ PNOZ ml2p | To safely connect a base unit to up to 4 decentralised modules PDP |

| Features | Order numbers | | |
|---|---|-------------------------|-------------------------|
| | Excl. terminals | Spring-loaded terminals | Plug-in screw terminals |
| <ul style="list-style-type: none"> ▶ Monitoring of 2 independent axes (8 limit frequencies can be selected) ▶ Connection per axis: 1 incremental encoder or 2 proximity switches or one of each ▶ Encoder types can be selected in the PNOZmulti Configurator ▶ Proximity detectors are connected directly to the terminals | 773 800 | 783 800 (1 set) | 793 800 (1 set) |
| | 773 810 | | |
| <ul style="list-style-type: none"> ▶ Incremental encoder with differential output signals from 12 Vss to 30 Vss, i.e. now also suitable for HTL encoders ▶ Independent from the supply voltage of the incremental encoder, i.e. also for encoders with 8 V supply voltage, for example | 773 815 | | |
| - | <ul style="list-style-type: none"> ▶ PNOZ ms2p TTL _ 773 816 ▶ PNOZ ms2p TTL coated version ___ 773 811 | | |
| - | 773 820 | | |
| <ul style="list-style-type: none"> ▶ Monitoring of 2 independent axes (8 limit frequencies can be selected) ▶ Connection per axis: 1 incremental encoder with differential output signals from 12 Vss to 30 Vss | 773 825 | | |
| <ul style="list-style-type: none"> ▶ Monitoring of 2 independent axes (8 limit frequencies can be selected) ▶ Connection per axis: 1 incremental encoder 0.5 Vss to 5 Vss | 773 826 | | |
| <ul style="list-style-type: none"> ▶ Monitoring of 1 axis (16 limit frequencies can be selected) ▶ Connection per axis: 1 incremental encoder 0.5 Vss to 30 Vss | 773 830 | | |



| Features | Order numbers | | |
|--|---|-------------------------|-------------------------|
| | Excl. terminals | Spring-loaded terminals | Plug-in screw terminals |
| <ul style="list-style-type: none"> ▶ Point-to-point connection via 4-core shielded, twisted-pair cable ▶ Transfer of 32 bit input data and 32 bit output data (virtual I/Os) ▶ Max. 4 PNOZ ml1p units can be connected to the base unit | <ul style="list-style-type: none"> ▶ PNOZ ml1p _____ 773 540 ▶ PNOZ ml1p coated version ___ 773 545 | 783 400 (1 set) | 793 400 (1 set) |
| <ul style="list-style-type: none"> ▶ Max. 4 PNOZ ml2p can be connected to the base unit ▶ Max. 4 decentralised modules PDP67 F 8DI ION can be connected to the link module PNOZ ml2p | 773 602 | | |

Technical documentation on the configurable control system PNOZmulti:

Webcode 0685

Online information at www.pilz.com

★ Type recommended by Pilz

► Technical details – PNOZmulti



Fieldbus modules – PNOZmulti communication modules

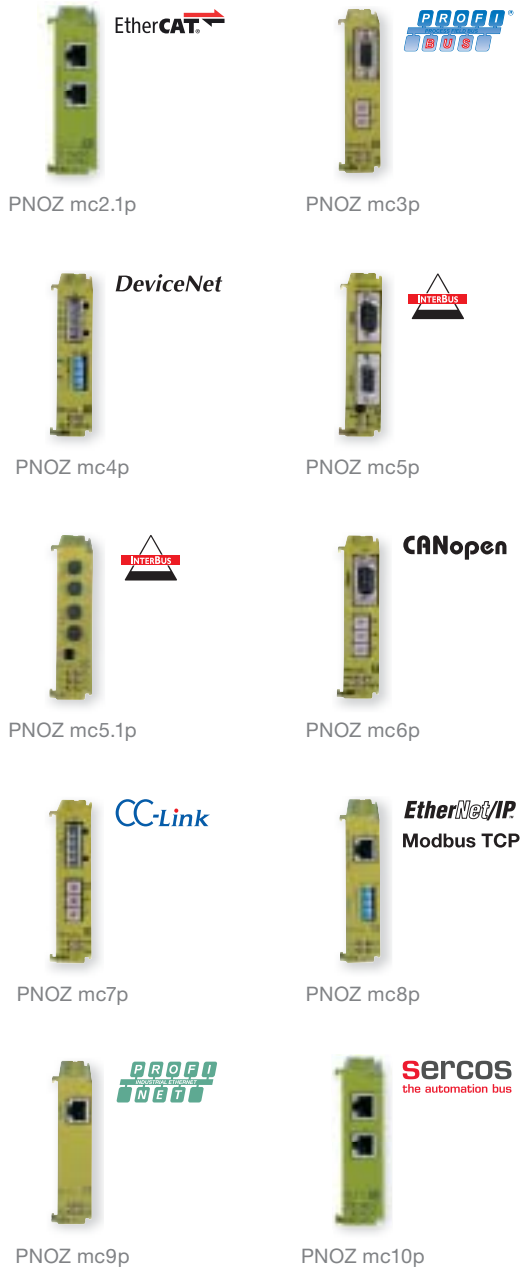

| Type | Scope |
|--|---|
| PNOZ mc2p, PNOZ mc2.1p | EtherCAT fieldbus module subscriber (slave), supports CANopen over EtherCAT |
| ★ PNOZ mc3p | PROFIBUS-DP fieldbus module subscriber (slave) |
| PNOZ mc4p, PNOZ mc4p coated version | DeviceNet fieldbus module subscriber (slave) |
| PNOZ mc5p | Interbus fieldbus module subscriber (slave) |
| PNOZ mc5.1p | Interbus fibre-optic (FO) fieldbus module subscriber (slave) |
| PNOZ mc0p Powersupply | Power supply for Interbus fieldbus modules PNOZ mc5p/PNOZ mc5.1p |
| PNOZ mc6p, PNOZ mc6p coated version, PNOZ mc6.1p | CANopen fieldbus module subscriber (slave) |
| PNOZ mc7p, PNOZ mc7p coated version | CC-Link fieldbus module subscriber (slave) |
| PNOZ mc8p, PNOZ mc8p coated version | Fieldbus module subscriber to EtherNet IP or Modbus TCP (slave) |
| PNOZ mc9p | Fieldbus module subscriber on PROFINET |
| PNOZ mc10p | Sercos III fieldbus module subscriber (slave) |

Common features

- Can be configured in the PNOZmulti Configurator
- Data can be used for visualisation/diagnostics or for control
- Status indicators via LEDs
- Max. 1 fieldbus module can be connected to the base unit
- Connection to the base unit using jumpers on the back of the unit

| Dimensions (L x W x H) in mm | Features | Order numbers |
|---------------------------------|--|--|
| 94 x 22,5 x 114 | <ul style="list-style-type: none"> ▶ Transmission rate: Max. 100 MBit/s ▶ Connection to fieldbus via RJ45 connector | <ul style="list-style-type: none"> ▶ PNOZ mc2p ____ 773 710 ▶ PNOZ mc2.1p ____ 773 713 |
| 94 x 22,5 x 119 | <ul style="list-style-type: none"> ▶ Station addresses from 0 ... 99, selected via rotary switch ▶ Transmission rate: Max. 12 MBit/s ▶ Connection: Female 9-pin Sub-D connector | 773 732 |
| 94 x 22,5 x 122 | <ul style="list-style-type: none"> ▶ Station addresses from 0 ... 63, selected via DIP switch ▶ Transmission rate: 125, 250, 500 kBit/s ▶ Connection to fieldbus via 5-pin Combicon plug-in connector | <ul style="list-style-type: none"> ▶ PNOZ mc4p ____ 773 711 ▶ PNOZ mc4p coated version ____ 773 729 |
| 94 x 22,5 x 119 | <ul style="list-style-type: none"> ▶ Transmission rate: 500 kBit/s, 2 MBit/s, selected via jumper ▶ Connection to IBS IN via male 9-pin Sub-D connector, to IBS OUT via female 9-pin Sub-D connector | 773 723 |
| 94 x 22,5 x 121 | <ul style="list-style-type: none"> ▶ Transmission rate: 500 kBit/s, 2 MBit/s, selected via jumper ▶ Status indicators for communication with Interbus and for errors ▶ Connection to fieldbus via F-SMA connector | 773 728 |
| 94 x 22,5 x 121 | <ul style="list-style-type: none"> ▶ Interface to connect the base unit and a fieldbus module ▶ Galvanic isolation ▶ Status indicators ▶ Plug-in terminals (either with spring-loaded terminals or screw connection) | <ul style="list-style-type: none"> ▶ PNOZ mc0p Powersupply ____ 773 720 ▶ Spring-loaded terminals (1 Set) ____ 783 400 ▶ Plug-in screw terminals (1 Set) ____ 793 400 |
| 94 x 22,5 x 119 | <ul style="list-style-type: none"> ▶ Station addresses from 0 ... 99, selected via rotary switch ▶ Transmission rate: Max. 800 kBit/s, selected via rotary switch ▶ Supported protocols: <ul style="list-style-type: none"> - PNOZ mc6p: CiA DS-301 V3.0 - PNOZ mc6.1p: CiA DS-301 V4.0.2 ▶ Connection to fieldbus via male 9-pin D-Sub connector | <ul style="list-style-type: none"> ▶ PNOZ mc6p ____ 773 712 ▶ PNOZ mc6p coated version ____ 773 727 ▶ PNOZ mc6.1p ____ 773 733 |
| 94 x 22,5 x 122 | <ul style="list-style-type: none"> ▶ Station addresses from 0 ... 63, selected via rotary switch ▶ Occupied stations: 2 ▶ Transmission rate: Max. 10 MBit/s, selected via rotary switch ▶ Connection: 5-pin Combicon plug-in connector | <ul style="list-style-type: none"> ▶ PNOZ mc7p ____ 773 726 ▶ PNOZ mc7p coated version ____ 773 725 |
| 94 x 22,5 x 114 | <ul style="list-style-type: none"> ▶ Transmission rate: Max. 10 MBit/s ▶ IP address is set using DIP switches on the front of the unit ▶ Connection to fieldbus via RJ45 connector | <ul style="list-style-type: none"> ▶ PNOZ mc8p ____ 773 730 ▶ PNOZ mc8p coated version ____ 773 734 |
| 94 x 22,5 x 114 | <ul style="list-style-type: none"> ▶ Device name can be configured in the PNOZmulti Configurator ▶ Diagnostics and alarm function are not supported ▶ Transmission rate: 100 MBit/s ▶ Connection to fieldbus via RJ45 connector | 773 731 |
| 94 x 22,5 x 114 | <ul style="list-style-type: none"> ▶ Transmission rate: Max. 100 MBit/s ▶ Connection to fieldbus via RJ45 connector | 773 715 |

★ Type recommended by Pilz



Technical documentation on the configurable control system PNOZmulti:

Webcode 0685

Online information at www.pilz.com

► Configurable control system PNOZmulti 2 – The

The configurable control system PNOZmulti has been on the market since 2002. It is used in countless applications and today is the most widely used safety system in the world. The secret of its success is the software tool PNOZmulti Configurator – ingeniously simple, simply ingenious. Now the success story is being updated with the PNOZmulti 2 – the Configurator remains as simple and flexible as it ever was.

10
YEARS
INNOVATION
PNOZmulti



The look of a bestseller – today and tomorrow!

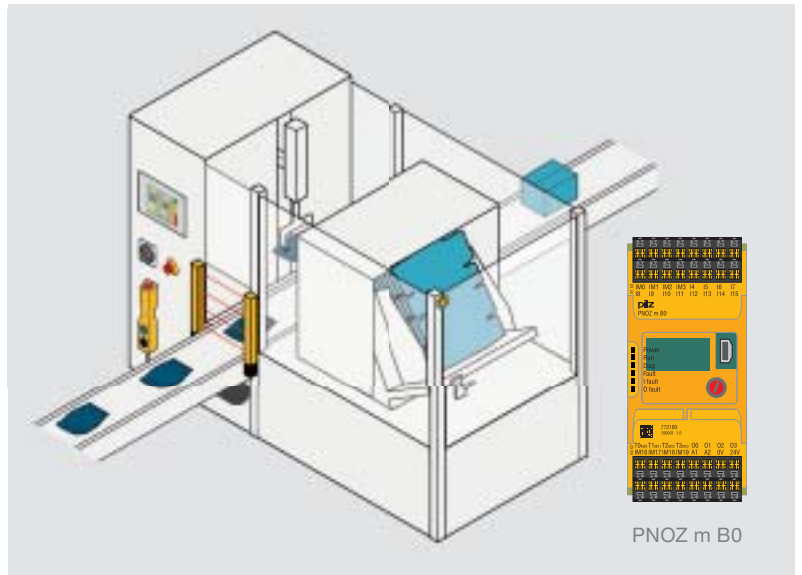

success-story continues

The hardware offers some interesting features. A totally new base unit and input/output module are available for your application. Further expansion modules are planned. At just 45 mm wide, the base unit PNOZ m B0 saves space in the control cabinet. It has an illuminated display, enabling rapid diagnostics as well as commissioning. Expansion using I/O modules increases the system's flexibility.

And you can look forward to future developments. With the PNOZmulti you can play it safe – it's the worldwide safety standard for all machine types. Irrespective of the standard control system, you will always have a one-stop safety solution, which can easily be adapted to changing requirements.

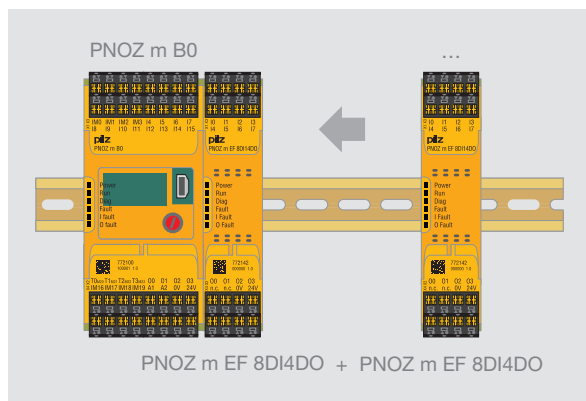

Expansion modules increase the system's flexibility.

Your benefits at a glance

- ▶ Efficient from three safety functions onwards
- ▶ Saves time and costs in all engineering phases due to the software tool PNOZmulti Configurator.
- ▶ Maximum flexibility and rapid time-to-market: inputs and outputs are freely configurable
- ▶ Saves lots of space in the control cabinet due to the compact design
- ▶ Simple diagnostics due to integrated, illuminated display
- ▶ Reduced downtimes thanks to PVIS support
- ▶ Customer texts can be displayed
- ▶ Worldwide safety standard for all machine types



Simply order the demo CD-ROM – you'll be amazed.

Keep up-to-date on the configurable control system PNOZmulti 2:

 Webcode 5245

Online information at www.pilz.com

► Technical details – PNOZmulti 2

Configurable control system PNOZmulti 2



PNOZ m B0



PNOZ m EF 8DI4DO

| Type | Scope |
|------------------|--|
| PNOZ m B0 | <p>Base unit – modular and expandable from 4 safety functions and for standard control functions</p> <p>All base units comply with Performance Level (PL) e of EN ISO 13849-1 and Safety Integrity Level (SIL) CL claim limit 3 of IEC 62061 Maximum achievable value, depending on the application, e.g. number of outputs.</p> |
| PNOZ m EF 8DI4DO | Safe input/output module |

| Features | Order numbers | | |
|---|--|-------------------------|-------------------------|
| | Excl. terminals | Spring-loaded terminals | Plug-in screw terminals |
| <ul style="list-style-type: none"> ▶ Application area: to connect emergency stop devices, two-hand buttons, safety gate limit switches, light beam devices, scanners, enabling switches, safety gate switches PSEN, operating mode selector switches, muting, pressure sensitive mats, sensors ▶ Configurable using PNOZmulti Configurator via chip card or USB interface ▶ Exchangeable program memory ▶ 20 inputs, up to 8 of which can be configured as auxiliary outputs ▶ 4 safe semiconductor outputs (PL e, SIL CL 3) ▶ 4 test pulse outputs, up to 4 of which can be configured as standard outputs ▶ Supply voltage (U_B): 24 VDC ▶ Voltage/current/rating: 24 VDC/2 A/48 W, outputs using semiconductor technology ▶ With illuminated display for error messages, state of the supply voltage, state of the inputs and outputs, status and device information, customised texts can be displayed ▶ Rotary knob for menu control ▶ Dimensions (H x W x D) in mm: 101.4 x 45 x 120 | 772 100 Mini USB cable ▶ 3 m _____ 312 992 ▶ 5 m _____ 312 993 ▶ Chip card 8 kByte, 1 piece _____ 779 201 ▶ Chip card 32 kByte, 1 piece _____ 779 211 | 751 008 (1 set) | 750 008 (1 set) |
| <ul style="list-style-type: none"> ▶ Inputs/outputs: <ul style="list-style-type: none"> - 8 safe inputs - 4 safe semiconductor outputs (PL e, SIL CL 3) ▶ Supply voltage: 24 VDC via module | 772 142 | 751 004 (1 set) | 750 004 (1 set) |



Technical documentation on the configurable control system PNOZmulti 2:

Webcode 0685

Online information at www.pilz.com

► Accessories – PNOZmulti

Accessories – Configurable control system PNOZmulti



Chipkarte



PSEN ma adapter



PNOZ msi1AP

| Type | Scope |
|--|--|
| Chip card Chipkarte | - |
| Chip card holder Chipkartenhalter | - |
| Chip card reader Chipkartenlesegerät | - |
| Labels for chip card Aufkleber für Chipkarte | - |
| SafetyNET p cable SafetyNET p Kabel | Connection cable for PNOZ mml1p |
| SafetyNET p Connector RJ45, plug-in connector SafetyNET p Connector RJ45, Steckverbinder | - |
| PNOZ mli1p | Connection cable for the PNOZ ml1p |
| PSEN ma adapter | Adapter for connection to safety switch PSENmag |
| PSEN cs adapter | Adapter for connection to safety switch PSENcode |
| PSS SB BUSCABLE | LC cable |
| PNOZ msi1Ap Adapter Si/Ha 25/25 | Connection cable for PNOZ ms1p/PNOZ ms2p/PNOZ ms3p to connect incremental encoders |
| PNOZ msi1Bp Adapter Si/Ha 25/25 | |
| PNOZ msi3Ap Adapter Si/Ha 15/15 | |
| PNOZ msi3Bp Adapter Si/Ha 15/15 | |
| PNOZ msi5p Adapter Bos/Rex 15/15 | |
| PNOZ msi6p Adapter Elau 9/9 | |
| PNOZ msi7p Adapter SEW 15/15 | |
| PNOZ msi8p Adapter Lenze 9/9 | |
| PNOZ msi9p adapter cable | |
| PNOZ msi19p ADAPTER ELAU PACDrive3 | |
| PNOZ msi S09 | - |
| PNOZ msi S15 | - |
| PNOZ msi S25 | - |

| Features | Order numbers | Spring-loaded terminals | Plug-in screw terminals | |
|--|--|--|--|---|
| | | | | |
| - | <ul style="list-style-type: none"> ▶ 8 kByte, 1 piece ____ 779201 ▶ 8 kByte, 10 pieces __ 779200 ▶ 32 kByte, 1 piece ____ 779211 ▶ 32 kByte, 10 pieces __ 779212 | - | - | |
| - | 779240 | - | - | |
| - | 779230 | - | - | |
| 10 pieces | 779250 | - | - | |
| 1 ... 500 m | 380000 | - | - | |
| - | 380400 | - | - | |
| <ul style="list-style-type: none"> ▶ Ready-made as spring-loaded or screw terminal type ▶ Shielded | - | <ul style="list-style-type: none"> ▶ 5 m _____ 773893 ▶ 10 m _____ 773894 ▶ 50 m _____ 773895 | <ul style="list-style-type: none"> ▶ 5 m _____ 773890 ▶ 10 m _____ 773891 ▶ 50 m _____ 773892 | |
| - | 380300 | - | - | |
| - | 380301 | - | - | |
| <ul style="list-style-type: none"> ▶ Shielded ▶ 1 ... 100 m | 311074 | - | - | |
| <ul style="list-style-type: none"> ▶ Used to connect an incremental encoder to the speed monitors PNOZ ms1p/PNOZ ms2p/PNOZ ms3p ▶ Connection cable for all common makes of drive ▶ Connection to drive and incremental encoder via 25-pin or 15-pin D-Sub male and female connector, or wired with stranded cable | <ul style="list-style-type: none"> ▶ 2.5 m ____ 773840 ▶ 5 m ____ 773844 | - | - | |
| | <ul style="list-style-type: none"> ▶ 2.5 m ____ 773841 ▶ 5 m ____ 773839 | - | - | |
| | <ul style="list-style-type: none"> ▶ 2.5 m ____ 773842 | - | - | |
| | <ul style="list-style-type: none"> ▶ 2.5 m ____ 773843 | - | - | |
| | <ul style="list-style-type: none"> ▶ 2.5 m ____ 773857 ▶ 1.5 m ____ 773858 | - | - | |
| | <ul style="list-style-type: none"> ▶ 7.5 m ____ 773859 ▶ 2.5 m ____ 773860 ▶ 1.5 m ____ 773861 | - | - | |
| | <ul style="list-style-type: none"> ▶ 2.5 m ____ 773864 ▶ 1.5 m ____ 773865 | - | - | |
| | <ul style="list-style-type: none"> ▶ 2.5 m ____ 773862 ▶ 1.5 m ____ 773863 | - | - | |
| | <ul style="list-style-type: none"> ▶ 5.0 m ____ 773856 ▶ 2.5 m ____ 773854 ▶ 1.5 m ____ 773855 | - | - | |
| | <ul style="list-style-type: none"> ▶ 2.5 m ____ 773847 ▶ 1.5 m ____ 773846 | - | - | |
| | 9-pin adapter, connector set | 773870 | - | - |
| | 15-pin adapter, connector set | 773871 | - | - |
| | 25-pin adapter, connector set | 773872 | - | - |

Technical documentation on the configurable control system PNOZmulti:

 Webcode 0685

Online information at www.pilz.com

► Decentralised modules PDP67 and PDP20

With the PDP67 modules you can achieve a high level of decentralisation. The digital input module PDP67 F 8DI ION forwards signals from decentralised sensors in the field to various evaluation devices, such as PNOZmulti Mini and PNOZmulti, for example. Up to 64 sensors can be connected.



PDP67 F 8DI ION

Decentralised and passive – decentralised safety

The passive junction PDP67 F 4 code enables the connection of up to four sensors PSENSlock or PSENini. As well as the ability to connect to the configurable control systems PNOZmulti and PNOZmulti Mini, the safety relays PNOZsigma are also available.

Versatile automation architectures are possible due to the ability to connect various evaluation devices.

PDP67 – Economical and safe

Incorporated into dirt and water-repellent IP67 housing, the PDP67 modules can be used even where there are high demands on hygiene. The decentralised modules optimise the installation and wiring effort – saving you time, money and space in the control cabinet. PDP67 modules with stainless steel threads satisfy the requirements of the food industry.

Type code for decentralised modules PDP67

PDP67 F 8DI ION HP VA

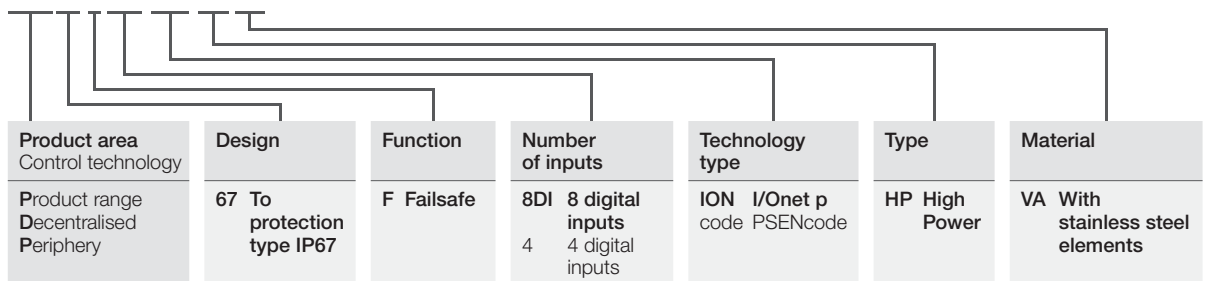

Keep up-to-date
on decentralised
modules:
PDP67

Webcode 6557

PDP20

Webcode 8459

Online information
at www.pilz.com



PDP20

PDP20 – Series connection up to PL e

The interface module PDP20 F 4 mag is ideally suitable for series connection of contact-based sensors, with N/O/N/O contacts such as PSEnmag, up to PL e. As such it provides a standard-compliant solution in accordance with EN ISO 13849-1. The interface module can be connected to dual-channel evaluation devices (e.g. PNOZsigma, PNOZmulti, PSS, ...). Up to four sensors can be connected to each PDP20 module.

It is also possible to cascade the PDP20 modules. In this case, each cascaded module provides three sensor interfaces.

Your benefits at a glance

- ▶ Simple installation means less planning, design and installation work
- ▶ Easy to implement a modular machine concept
- ▶ Just one cable for communication and supply, plug and play via M12 plug-in connector
- ▶ Simple diagnostics due to a point-to-point connection between the modules (each module can be identified)
- ▶ Individual sensors can be diagnosed on the modules



Selection guide – Modules for alternative connection options for sensors



PDP67 F 4 code



PDP67 Connector cs



PDP20 F 4 mag

| Type | Features | Safety | Order numbers |
|---|--|--|---|
| PDP67 F 8DI ION, PDP67 F 8DI ION VA | Decentralised input module for PNOZmulti and PNOZmulti Mini | <ul style="list-style-type: none"> ▶ PL e of EN ISO 13849-1 ▶ SIL CL 3 of EN/IEC 62061 | <ul style="list-style-type: none"> ▶ PDP67 F 8DI ION _____ 773600 ▶ PDP67 F 8DI ION VA _____ 773614 |
| PDP67 F 8DI ION HP, PDP67 F 8DI ION HP VA | Decentralised input module for PNOZmulti and PNOZmulti Mini; high power; additional supply voltage for PSEnSlock and PSEnOpt | | <ul style="list-style-type: none"> ▶ PDP67 F 8DI ION HP _____ 773601 ▶ PDP67 F 8DI ION HP VA _____ 773615 |
| PDP67 F 4 code, PDP67 F 4 code VA | Passive junction PSEncode | | <ul style="list-style-type: none"> ▶ PDP67 F 4 code _____ 773603 ▶ PDP67 F 4 code VA _____ 773613 |
| PDP67 Connector cs, PDP67 Connector cs VA | Adapter for connection cable to the evaluation device | | <ul style="list-style-type: none"> ▶ PDP67 Connector cs _____ 773610 ▶ PDP67 Connector cs VA _____ 773612 |
| PDP20 F 4 mag | Decentralised interface for series connection PSEnmag | <ul style="list-style-type: none"> ▶ PL e of EN ISO 13849-1 ▶ SIL CL 3 of EN/IEC 62061 | 773310 |

► Cable navigator

The cable navigator provides assistance as you create your application. It provides a fast, simple overview of which cable and which adapter can be used to connect to the respective evaluation device and on various sensors.

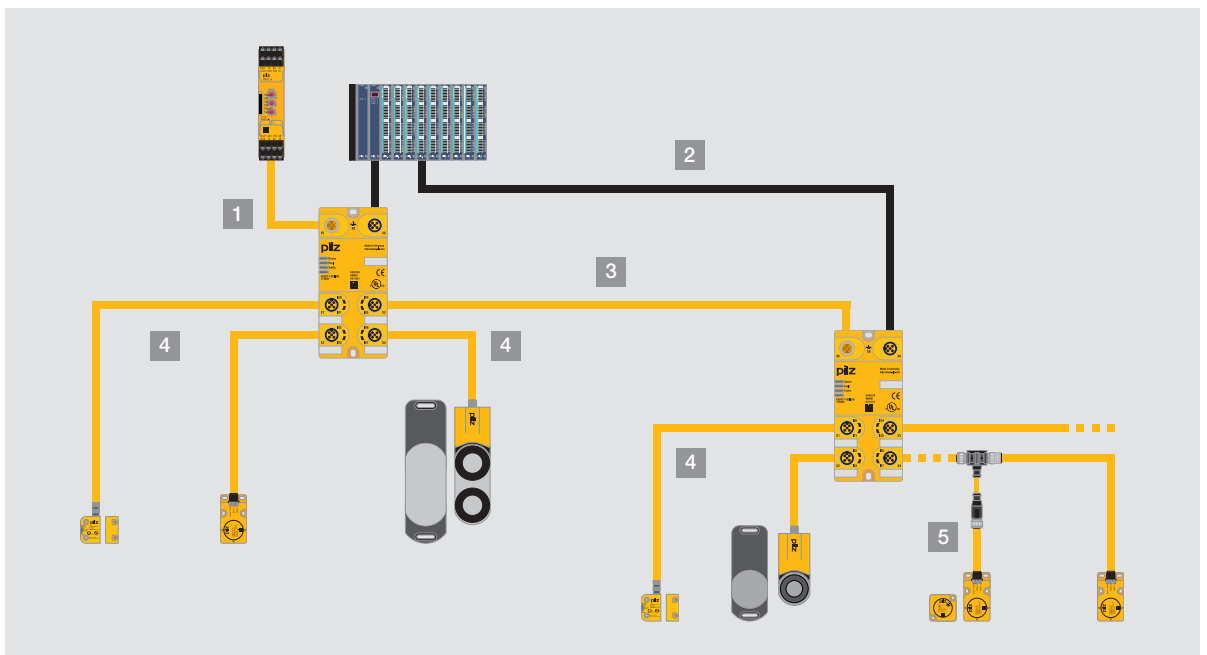

Cable navigator

| Type | Features | Order numbers | | | | | |
|---|--|---------------|---------|---------|---------|---------|---------|
| | | | 2 m | 5 m | 10 m | 20 m | 30 m |
| 1 Connection cable evaluation device – PDP67 (X5) | PDP67 cable, straight, M12, 8-pin, open-ended connector | - | 380 700 | 380 701 | 380 702 | 380 703 | 380 704 |
| 2 Connection cable standard evaluation device – PDP67 (X6) | PDP67 cable, straight, M12, 8-pin, open-ended connector | - | 380 700 | 380 701 | 380 702 | 380 703 | 380 704 |
| 3 Connection cable PDP67 (X1-X4) – PDP67 (X5) | PSEN cable, straight, M12, 8-pin, plug/socket | - | 540 340 | 540 341 | 540 342 | 540 343 | 540 344 |
| 4 Connection cable PSENcode, PSENslock, PSENiini (X1-X4) | PSEN cable, straight, M12, 8-pin, plug/socket | - | 540 340 | 540 341 | 540 342 | 540 343 | 540 344 |
| 5 PSEN Y-junction/ PSEN T-junction | PSEN Y-junction M8-M12/M12 Series connection with M8, 8-pin | 540 327 | - | - | - | - | - |
| | PSEN Y-junction M12-M12/M12 Series connection with M12, 8-pin | 540 328 | - | - | - | - | - |
| | PSEN T-junction M12 diagnostic connector | 540 331 | - | - | - | - | - |

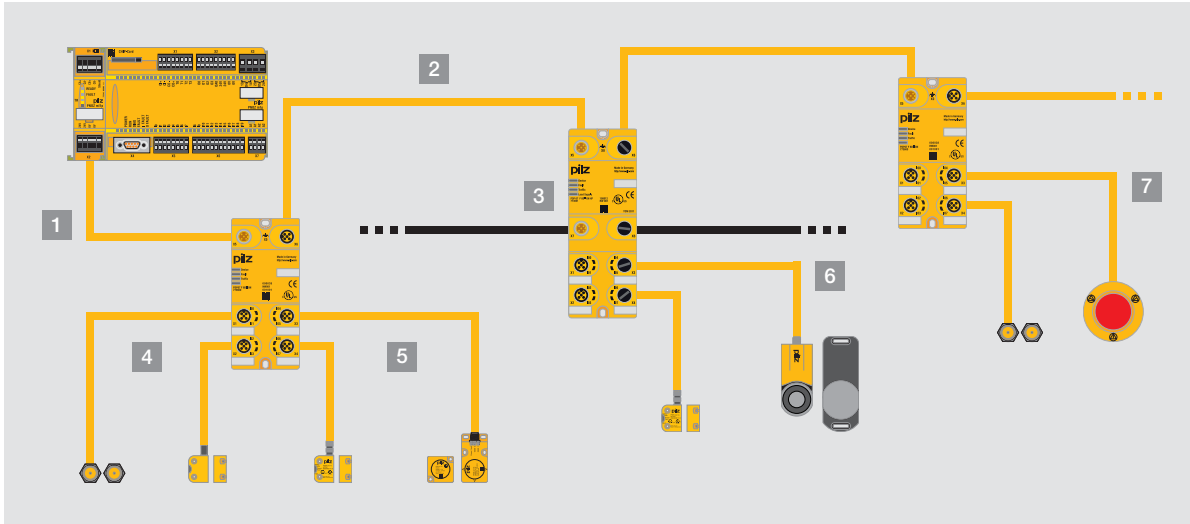

Cable navigator

| Type | Features | Order numbers | | | | | |
|---|---|---------------|---------|---------|---------|---------|---------|
| | | 3 m | 5 m | 10 m | 20 m | 30 m | |
| 1 Connection cable PNOZ ml2p/PNOZ mml2p – PDP67 (X5) | PSEN op cable, straight, M12, 5-pin, open-ended socket | - | 630 310 | 630 311 | 630 312 | 630 298 | 630 297 |
| 2 Connection cable PDP67 (X6) – PDP67 (X5) | PSS67 cable, straight, M12, 5-pin, plug/socket | - | 380 208 | 380 209 | 380 210 | 380 220 | 380 211 |
| 3 Supply cable PDP67 F 8DI ION HP (X7-X8) | X7: PSS67 supply cable, straight, M12, 5-pin, open-ended socket, B-coded | - | 380 256 | 380 257 | 380 258 | - | - |
| | X8 – X7: PSS67 supply cable, straight, M12, 5-pin, plug/socket, B-coded | - | 380 250 | 380 251 | 380 252 | - | - |
| 4 Connection cable PSEnmag (X1-X4) | n-type: PSS67 cable, straight, M12, 5-pin, plug/socket | - | 380 208 | 380 209 | 380 210 | 380 220 | 380 211 |
| | p-type (M8-4pin): PSS67 cable, straight, M8, 5-pin, socket, M12, 5-pin, connector | - | 380 200 | 380 201 | 380 202 | 380 203 | - |
| | Adapter PSEN mag adapter | 380 300 | - | - | - | - | - |
| 5 Connection cable PSENcode (X1-X4) | n-type: PSS67 cable, straight, M12, 5-pin, plug/socket | - | 380 208 | 380 209 | 380 210 | 380 220 | 380 211 |
| | p-type: PSS67 cable, straight, M12, 5-pin, plug/socket | - | 380 208 | 380 209 | 380 210 | 380 220 | 380 211 |
| | Adapter PSEN cs adapter | 380 301 | - | - | - | - | - |
| 6 Connection cable PSENslock (X1-X4) | n-type: PSS67 cable, straight, M12, 5-pin, plug/socket | - | 380 208 | 380 209 | 380 210 | 380 220 | 380 211 |
| | p-type: PSS67 cable, straight, M12, 5-pin, plug/socket | - | 380 208 | 380 209 | 380 210 | 380 220 | 380 211 |
| | Adapter PSEN sl adapter | 380 325 | - | - | - | - | - |
| 7 Connection cable PIT, sensors without M12 connection (X1-X4) | PDP67 cable, straight, M12, 5-pin, open-ended connector | - | 380 705 | 380 709 | 380 706 | 380 707 | 380 708 |

► Consulting, engineering and training

As a solution supplier, Pilz can help you to apply optimum safety strategies worldwide. Services encompass the whole machine lifecycle. Our training package with practical, up-to-date course content completes the offering.



Safety services: Consulting and engineering

Your projects belong in safe hands.



Risk Assessment

We inspect your machines in accordance with the applicable standards and/or international standards and directives and assess the existing hazards.



Safety Concept

We develop detailed technical solutions for the safety of your plant and machinery through mechanical, electronic and organisational measures.



Safety Design

The aim of the Safety Design is to reduce or eliminate danger points through detailed planning of the necessary safeguards.



System Implementation

The results from the Risk Assessment and Safety Design are implemented through selected, tailor-made safety measures



Services related to machinery safety:

 Webcode 7792

Online information at www.pilz.com



Safety Validation

The Risk Assessment and the Safety Concept are mirrored and examined by competent specialist staff in the Safety Validation.





CE Marking

We manage all the activities and processes for the necessary conformity assessment procedure, including the required technical documentation.



International Compliance Services

We perform the assessment procedure and develop the necessary strategies to enable compliance with the respective ISO, IEC, ANSI, EN or other national or international standards.



Plant Assessment

We develop an overview of your entire plant in the shortest possible time. We use an on-site inspection to expose the risks and calculate the cost of optimising your safeguards.



Inspection of Safeguarding Devices

With our independent, DAkkS accredited inspection body in accordance with ISO 17020, we guarantee objectivity and high availability for your machinery.



Pilz GmbH & Co. KG, Ostfildern, operates an independent inspection body in accordance with DIN EN ISO/IEC 17020:2004 for the plant and machinery sector, accredited by the German Accreditation Body (DAkkS).

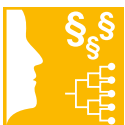

Machinery Safety in the Workplace

We offer additional tailor-made services to assure compliance and safety in the workplace in accordance with local standards and regulations.



Knowledge gives you a competitive edge – Training from Pilz:

 Webcode 0218



Safety services: Training

Pilz offers two types of training: product-neutral seminars on machinery safety and specific product courses. We pass on professional expertise in a practical, understandable format.



Online information at www.pilz.com

Contact

AT

Pilz Ges.m.b.H.
Sichere Automation
Modecenterstraße 14
1030 Wien
Austria
Telephone: +43 1 7986263-0
Telefax: +43 1 7986264
E-Mail: pilz@pilz.at
Internet: www.pilz.at

AU

Pilz Australia
Safe Automation
Unit D7, Hallmarc Business park Clayton
Corner of Westall and Centre roads
Clayton, Melbourne, Victoria 3168
Australia
Telephone: +61 3 95446300
Telefax: +61 3 95446311
E-Mail: safety@pilz.com.au
Internet: www.pilz.com.au

BE, LU

Pilz Belgium
Safe Automation
Bijenstraat 4
9051 Gent (Sint-Denijs-Westrem)
Belgium
Telephone: +32 9 3217570
Telefax: +32 9 3217571
E-Mail: info@pilz.be
Internet: www.pilz.be

BR

Pilz do Brasil
Automacao Segura
Av. Senador Vergueiro,
347/355 -Jd. do Mar
CEP: 09750-000
São Bernardo do Campo - SP
Brazil
Telephone: +55 11 4126-7290
Telefax: +55 11 4942-7002
E-Mail: pilz@pilz.com.br
Internet: www.pilz.com.br

CH

Pilz Industrieelektronik GmbH
Gewerbepark Hintermättli
Postfach 6
5506 Mägenwil
Switzerland
Telephone: +41 62 88979-30
Telefax: +41 62 88979-40
E-Mail: pilz@pilz.ch
Internet: www.pilz.ch

CN

Pilz Industrial Automation
Trading (Shanghai) Co., Ltd.
Rm. 1702-1704
Yongda International Tower
No. 2277 Long Yang Road
Shanghai 201204
China
Telephone: +86 21 60880878
Telefax: +86 21 60880870
E-Mail: sales@pilz.com.cn
Internet: www.pilz.com.cn

DE

Pilz GmbH & Co. KG
Felix-Wankel-Straße 2
73760 Ostfildern
Germany
Telephone: +49 711 3409-0
Telefax: +49 711 3409-133
E-Mail: info@pilz.de
Internet: www.pilz.de

DK

Pilz Skandinavien K/S
Safe Automation
Ellegaardvej 25 L
6400 Sonderborg
Denmark
Telephone: +45 74436332
Telefax: +45 74436342
E-Mail: pilz@pilz.dk
Internet: www.pilz.dk

ES

Pilz Industrieelektronik S.L.
Safe Automation
Camí Ral, 130
Polígono Industrial Palou Nord
08401 Granollers
Spain
Telephone: +34 938497433
Telefax: +34 938497544
E-Mail: pilz@pilz.es
Internet: www.pilz.es

FI

Pilz Skandinavien K/S
Safe Automation
Nuijamiestentie 7
00400 Helsinki
Finland
Telephone: +358 10 3224030
Telefax: +358 9 27093709
E-Mail: pilz.fi@pilz.dk
Internet: www.pilz.fi

FR

Pilz France Electronic
1, rue Jacob Mayer
CS 80012
67037 Strasbourg Cedex 2
France
Telephone: +33 3 88104000
Telefax: +33 3 88108000
E-Mail: siege@pilz-france.fr
Internet: www.pilz.fr

GB

Pilz Automation Technology
Pilz House
Little Colliers Field
Corby
Northants NN18 8TJ
United Kingdom
Telephone: +44 1536 460766
Telefax: +44 1536 460866
E-Mail: sales@pilz.co.uk
Internet: www.pilz.co.uk

IE

Pilz Ireland Industrial Automation
Cork Business and Technology Park
Model Farm Road
Cork
Ireland
Telephone: +353 21 4346535
Telefax: +353 21 4804994
E-Mail: sales@pilz.ie
Internet: www.pilz.ie

IN

Pilz India Pvt Ltd.
Office No 202, Delite Square
Near Aranyeshwar Temple
Sahakar Nagar No 1
Pune 411009
India
Telephone: +91 20 2421399-4/-5
Telefax: +91 20 2421399-6
E-Mail: info@pilz.in
Internet: www.pilz.in

IT

Pilz Italia S.r.l.
Automazione sicura
Via Gran Sasso n. 1
20823 Lentate sul Seveso (MB)
Italy
Telephone: +39 0362 1826711
Telefax: +39 0362 1826755
E-Mail: info@pilz.it
Internet: www.pilz.it

In many countries we are represented by sales partners. Please refer to our homepage www.pilz.com for further details or contact our headquarters.

Contact

JP

Pilz Japan Co., Ltd.
Safe Automation
BENEX S-2 4F
3-17-5 Shin-Yokohama
Kohoku-ku
222-0033 Yokohama
Japan
Telephone: +81 45 471-2281
Telefax: +81 45 471-2283
E-Mail: pilz@pilz.co.jp
Internet: www.pilz.jp

KR

Pilz Korea Ltd.
Safe Automation
22F Keumkang
Penterium IT Tower Unit B
810 Gwanyang-dong, Dongan-gu
Anyang-si, Gyeonggi-do, 431-060
South Korea
Telephone: +82 31 450 0677
Telefax: +82 31 450 0670
E-Mail: info@pilzkorea.co.kr
Internet: www.pilzkorea.co.kr

MX

Pilz de México, S. de R.L. de C.V.
Automatización Segura
Convento de Actopan 36
Jardines de Santa Mónica
Tlalnepantla, Méx. 54050
Mexico
Telephone: +52 55 5572 1300
Telefax: +52 55 5572 1300
E-Mail: info@pilz.com.mx
Internet: www.pilz.mx

NL

Pilz Nederland
Veilige automatisering
Havenweg 22
4131 NM Vianen
Netherlands
Telephone: +31 347 320477
Telefax: +31 347 320485
E-Mail: info@pilz.nl
Internet: www.pilz.nl

NZ

Pilz New Zealand
Safe Automation
Unit 4, 12 Laidlaw Way
East Tamaki
Auckland 2016
New Zealand
Telephone: +64 9 6345350
Telefax: +64 9 6345352
E-Mail: office@pilz.co.nz
Internet: www.pilz.co.nz

PL

Pilz Polska Sp. z o.o.
Safe Automation
ul. Ruchliwa 15
02-182 Warszawa
Poland
Telephone: +48 22 8847100
Telefax: +48 22 8847109
E-Mail: info@pilz.pl
Internet: www.pilz.pl

PT

Pilz Industrieelektronik S.L.
R. Eng Duarte Pacheco, 120
4 Andar Sala 21
4470-174 Maia
Portugal
Telephone: +351 229407594
Telefax: +351 229407595
E-Mail: pilz@pilz.pt
Internet: www.pilz.pt

RU

Pilz RUS OOO
Ugreshskaya street, 2,
bldg. 11, office 16 (1st floor)
115088 Moskau
Russian Federation
Telephone: +7 495 665 4993
E-Mail: pilz@pilzrussia.ru
Internet: www.pilzrussia.ru

SE

Pilz Skandinavien K/S
Safe Automation
Energigatan 10 B
43437 Kungsbacka
Sweden
Telephone: +46 300 13990
Telefax: +46 300 30740
E-Mail: pilz.se@pilz.dk
Internet: www.pilz.se

TR

Pilz Emniyet Otomasyon
Ürünleri ve Hizmetleri Tic. Ltd. Şti.
Kayışdağı Cd. Beykonağı Plaza
No:130 K:2 D:2
Ataşehir/İstanbul
Turkey
Telephone: +90 216 5775550
Telefax: +90 216 5775549
E-Mail: info@pilz.com.tr
Internet: www.pilz.com.tr

US, CA

Pilz Automation Safety L.P.
7150 Commerce Boulevard
Canton
Michigan 48187
USA
Telephone: +1 734 354 0272
Telefax: +1 734 354 3355
E-Mail: info@pilzusa.com
Internet: www.pilz.us

In many countries we are represented by sales partners. Please refer to our homepage www.pilz.com for further details or contact our headquarters.

► Support

Technical support is available from Pilz round the clock. This service is provided free of charge beyond standard business hours.

Americas

Brazil

+55 11 97569-2804

Mexico

+52 55 5572 1300

USA (toll-free)

+1 877-PILZUSA (745-9872)

Asia

China

+86 21 60880878-216

Japan

+81 45 471-2281

South Korea

+82 31 450 0680

Australia

+61 3 95446300

Europe

Austria

+43 1 7986263-0

Belgium, Luxembourg

+32 9 3217575

France

+33 3 88104000

Germany

+49 711 3409-444

Ireland

+353 21 4804983

Italy

+39 0362 1826711

Scandinavia

+45 74436332

Spain

+34 938497433

Switzerland

+41 62 88979-30

The Netherlands

+31 347 320477

Turkey

+90 216 5775552

United Kingdom

+44 1536 462203

You can reach our international hotline on:

+49 711 3409-444

support@pilz.com

Pilz develops environmentally-friendly products using ecological materials and energy-saving technologies. Offices and production facilities are ecologically designed, environmentally-aware and energy-saving. So Pilz offers sustainability, plus the security of using energy-efficient products and environmentally-friendly solutions.

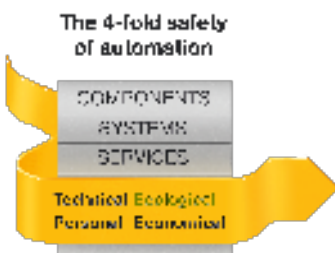

Presented by:



Pilz GmbH & Co. KG
Felix-Wankel-Straße 2
73760 Ostfildern, Germany
Tel.: +49 711 3409-0
Fax: +49 711 3409-133
info@pilz.com
www.pilz.com

pilz
the spirit of safety