



 <b>CARATTERISTICHE TECNICHE</b>	 <b>TECHNICAL FEATURES</b>	 <b>CARACTERISTIQUES TECHNIQUES</b>	 <b>TECHNISCHE DATEN</b>	 <b>CARACTERÍSTICAS TÉCNICAS</b>
<b>Prestazioni:</b> Fino a 150 conf/min <b>Dimensioni prodotto:</b> Larghezza: da 20 a 200 mm Altezza: da 1 a 100 mm Lunghezza: da 50 a 600 mm <b>Dimensioni bobina:</b> Fascia max 520 mm Diametro esterno 350 mm Diametro interno 68V75 mm <b>Materiali d'incarto:</b> Film termosaldanti Film accoppiati Film saldanti a freddo Polietilene <b>Dimensioni macchina:</b> Lunghezza: 3200 mm Larghezza: 890 mm Altezza: 1800 mm Peso: 550 kg	<b>Production speed:</b> Up to 150 ppm <b>Product dimensions:</b> Width: 20V200 mm Height: 1V100 mm Length: 50V600 mm <b>Reel dimensions:</b> Reel width max 520 mm Outside diameter: 350 mm Core diameter: 68V75 mm <b>Packaging materials:</b> Heat-sealable Coated Cold-sealable Polyethylene <b>Machine dimensions:</b> Length: 3200 mm Width: 890 mm Height: 1800 mm Machine weight: 550 Kg	<b>Cadence Mécanique:</b> Jusqu'à 150 sachets/minute <b>Dimensions Produit:</b> Largeur: 20V200 mm Hauteur: 1V100 mm Longueur: 50V600 mm <b>Dimensions Bobine:</b> Laize: max 520 mm Diamètre extérieur: 350 mm Diamètre intérieur 68V75 mm <b>Films d'emballage:</b> Films thermo soudants Films complexes Films soudants à froid Polyéthylène <b>Dimensions Machine:</b> Longueur: 3200 mm Largeur: 890 mm Hauteur: 1800 mm Poids de la machine: 550 Kg	<b>Leistung:</b> Bis 150 Packungen pro Minute <b>Produktabmessungen:</b> Breite: 20V200 mm Höhe: 1V100 mm Länge: 50V600 mm <b>Folienrollenabmessungen:</b> Max Breite: 520 mm Äußerer Durchmesser: 350 mm Kerndurchmesser: 68V75 mm <b>Verpackungsfolie:</b> Heißsiegelfähig Verbundfolie Kaltsiegelfähig PE <b>Maschinenabmessungen:</b> Länge: 3200 mm Breite: 890 mm Höhe: 1800 mm Maschinengewicht: 550 Kg	<b>Producción:</b> Hasta 150 ptes./min <b>Dimensiones de producto:</b> Anchos: de 20 a 200 mm Alturas: de 1 a 100 mm Longitudes: de 50 a 600 mm <b>Dimensiones bobina:</b> Ancho máximo de film 520 mm Diámetro externo, 350 mm Diámetro interno, 68V75 mm <b>Material de embalaje:</b> Film polipropileno Films laminados Films soldables en frío Polietileno <b>Dimensiones de la máquina:</b> Longitud: 3200 mm Ancho: 890 mm Altura: 1800 mm Peso: 550 kilos
<b>OPTIONAL</b> - Stampatore data scadenza - Fotocellula stampa centrata - Ruote sotto la macchina - Cambio passo corto/lungo - Doppio portabobina - Versione politene - Allungamento nastro alimentazione - Coltelli a zig-zag - Punzone euroslot (sombrello) - No product no bag - Alimentazione automatica - Molte altre soluzioni vengono proposte dal ns. staff tecnico in ordine alle singole esigenze	<b>OPTIONS</b> - Printing unit for expiry date - Photo electric cell for print register - Casters under the machine - Gear shift for short/long pitch - Double reel holder - Polythene version - Infeed extension - Zig-zag knives - Euroslot punch - No product no bag - Automatic feeding - Many other solutions can be proposed by our technical team according to the various requirements	<b>OPTIONS</b> - Système d'impression pour la date d'expiration - Cellule photo-électrique pour le centrage de l'impression - Roues en dessous de la machine - Changement pour pas long et court - Version polyéthylène - Allongement convoyeur alimentation - Couteaux zig-zag - Trou européen (euroslot) - Photocellule "Pas de produit - Pas de sachet" - Alimentation automatique - D'autres nombreuses solutions peuvent être proposées par notre bureau d'étude suivant les différentes exigences.	<b>OPTIONEN</b> - Druckgerät für Datum - Photozellensteuerung - Räder unter der Maschine - Two-speed infeed - Doppelte Rollenträger - PE Ausführung - Zufuhrband Verlängerung - Zick Zack Messer - Euroloch-Stempel - Kein Produkt-kein Beutel - Automatische Zufuhrsysteme - Weitere Lösungen können aufgrund der einzelnen Erfordernisse von unserem technischen Team vorgeschlagen werden	<b>OPCIONALES</b> - Marcador, codificador para fecha de caducidad y N° lote - Fotocélula para trabajar con film impreso - Ruedas para poder movilizar la máquina - Cambio de paso, corto - largo - Doble porta bobina - Versión polietileno - Prolongación cinta de carga - Cuchilla de corte a zig-zag. - Euroslot (para colgar el paquete) - No product - no bag - Alimentación automática - Otras soluciones que pueden comentar con nuestro personal especializado
<b>CARATT. ELETTRICHE E DI GESTIONE</b> - Controllo assi con PLC - Interfaccia tramite touch screen da 3,7" - Memorizzazione dati e ricette - Diagnostica macchina - Controllo temperature da touch screen - Potenza installata 3 KW	<b>ELECT. FEATURES AND CONT. SYSTEM</b> - Motion control with PLC - Interface through 3,7" touch screen - Working programs memorization - Machine diagnostic - Temperature control through touch screen - Power 3 KW	<b>CARACT. ELECTRIQUES ET DE GESTION</b> - Contrôle axes avec automate - Interface par écran tactile de 3,7" - Mémorisation données et programmes - Diagnostique machine - Contrôle température par écran tactile - Puissance installée 3 KW	<b>ELEKTRISCHE DATEN UND MASCHINENSTEUERUNG</b> - Achsenkontrolle mit SPS - 3,7" Touch Screen, um die Maschinendaten zu verändern und visualisieren - Speicherung Maschinenprogramme - Diagnostik - Temperatureinstellung vom Touch Screen - Spannungsanschluss 3 KW	<b>CARACTERÍSTICAS ELÉCTRICAS DE GESTIÓN</b> - Control mediante PLC - Interfase con pantalla táctil de 3,7 pulgadas - Memorias para diferentes programas de trabajo - Diagnóstico del equipo - Control de la temperatura a través de la pantalla táctil - Potencia instalada: 3 Kw
<b>CARATTERISTICHE PNEUMATICHE</b> Alimentazione aria compressa: 7 bar aria secca e filtrata	<b>PNEUMATIC FEATURES</b> Compressed air: 7 bar dry and filtered air	<b>CARACTERISTIQUES PNEUMATIQUES</b> Alimentation air comprimé: 7 bar air sec et filtré	<b>PRESSLUFT</b> 7 Bar trockene und filtrierte Luft	<b>CARACTERÍSTICAS NEUMÁTICAS</b> Alimentación con aire comprimido Presión: 7 Bar / Aire seco y filtrado



PH. Dvr fotografia  
acrobatservice

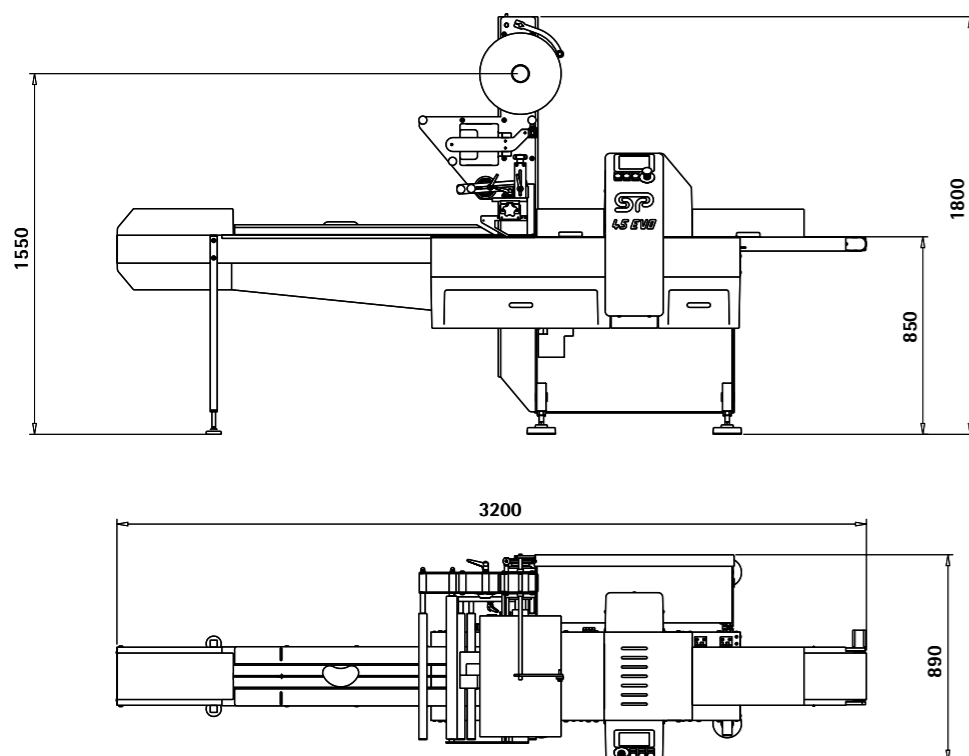

general system pack

General System Pack srl  
Via Lago di Molveno, 20 - 36015 SCHIO (VI) Italy  
tel. +39 0445.576.285 - fax +39 0445.576.286  
info@gsp.it www.gsp.it

PACKAGING INNOVATION

www.gsp.it



general system pack

PACKAGING INNOVATION



**IT** La GSP45 EVO è il risultato dell'evoluzione delle nostre macchine e di anni di esperienza nel campo del confezionamento dei prodotti in orizzontale. Confezionatrice elettronica, versatile e affidabile, estremamente flessibile nel cambio formato, ideale per prodotti alimentari e non, sia per monodose che per confezioni multiple. La sua struttura a sbalzo e la facile accessibilità le permettono di contraddistinguersi, così come per i principi di sanificabilità, semplicità di manutenzione e sicurezza per i quali è stata concepita.

**UK** GSP45 EVO is the result of our machines' evolution and of many experience's years in the field of horizontal products' packaging. Electronic Horizontal Pillow Pack Wrapper, versatile and reliable, very flexible in the format-change, suitable for food and non food products, both for single-dose and for multiple packages. Cantilever frame and easy accessibility, together with sanitation (sanification) principles, easy maintenance and safety, it has been constructed for, allows this wrapper to distinguish itself.

**FR** GSP45 EVO est le résultat de nos machines emballeuses et de plusieurs années d'expérience dans le domaine de l'emballage des produits en horizontale. Il s'agit d'une emballeuse électronique, polyvalente et fiable, extrêmement flexible en changement format, apte à emballer produits alimentaires et non, soit pour la paquet à dose unique soit pour le multipack. Sa structure en porte-à-faux et sa simple accessibilité, ensemble aux principes, pour lesquels elle a été construite, d'assainissement, de simple maintenance et de sécurité, permettent à cette machine de se distinguer.

**DE** Die GSP45 EVO ist das Ergebnis unserer Entwicklung und Erfahrung mit horizontalen Schlauchbeutel Verpackungsmaschinen. Die elektronische Schlauchbeutelmaschine ist: vielseitig, zuverlässig, äußerst flexibel im "Schlauchbeutel" Formatwechsel für den Food- und Non Food-Bereich geeignet. Die Maschine entspricht den neuesten CE-Vorschriften; ihre Balkon Struktur, Zugänglichkeit, die Sanierungsmöglichkeit und Bedienungsfreundlichkeit: Da wurde ein technisch-elektronisches Kunstwerk entwickelt.

**ES** La GSP 45 EVO, es el resultado de la evolución de nuestras máquinas y de muchos años de experiencia en el sector del embalaje de productos en horizontal (Flow-pack). Es una máquina electrónica, versátil y fiable, extremadamente flexible en cambio de formatos, ideal para trabajar con productos técnicos o alimentarios, embolsados de forma unitaria o en agrupaciones. El nuevo sistema de construcción vertical y la accesibilidad, marcan una diferenciación muy importante. Facilitando la higiene y el mantenimiento del equipo y cumpliendo las normativas de sanidad y seguridad europeas.

**GSP45EVO**  
www.gsp.it

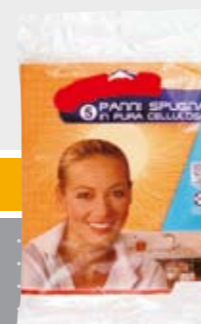
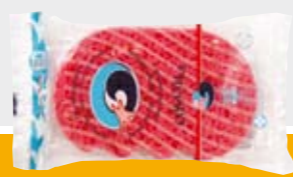

general system pack

PACKAGING INNOVATION